

35. EWU-Turnier

Niedertaufkirchen-Hinteralbing

13./14.07.2024



Pferdepenion ~ Guest-Ranch

Josef Fuchs
Pferdewirtschaftsmeister



Oberbayerische Meisterschaft 2024

ewu
Erste Westernreiterunion
Bayern e.V.



**Oberbayerischen Meisterschaft 2024
&
Wertungsturnier zum Sherwood 3R-Cup**

EWU – C-Turnier Niedertaufkirchen-Hinteralbing - Sherwoodranch

Turnierkategorie: EWU AQ-C-Turnier
Datum: 13. - 14.07.2024
Veranstaltungsort: Sherwoodranch, Hinteralbing 1, 84494 Niedertaufkirchen

Veranstalter: Josef Fuchs
Turnierorganisation/
Nennstelle: Volkhard Hummel - Tel.: 0170 380 25 52

Turnierleiter: Christine Hummel
Richter: Kathrin Brunner
Ringsteward: Sabine Kotzschmar
EWU-Steward: Angelina Dressel

Meldestelle: Stefan Pietsch – Tel.: 0151 - 68585446

Turniersprecher: Janina Löschner, Dirk Jungls
Doorman: Sigi Jahnel, Michael Stikar, Michi Haak
Parcoursdienst: Micha Hagendorn, Luna Schnitzler, Sophia
Schleifendienst: Hagendorn, Heike Kramer, Leni Demmelhuber, Luna
Schnitzler, Renate Lichtmannecker

Turniertierarzt: Marcus Menzel - Tel.: 0171 699 00 11
Sanitätsdienst: Nina Knapp - Tel.: 0151 445 15 979
Hufschmied: Ortwin Fincke – Tel.: 0171 218 68 51
Rettungsdienst: **112**

Turnierfotograf: Armin Pollak
Turnierbilder: www.arminpollak-fotografie.de

EWU - Steward: Angelina Dressel

0151 432 147 58

Öffnungszeiten der Meldestelle:

Abreitezeiten:

12.07.2024: 16:00 - 19:00

12.07.2024: 17:00 - 20:00

13.07.2024: 07:30 - 18:00

13.07.2024: 07:30 - 18:00

14.07.2024: 07:30 - 17:00

14.07.2024: 07:00 - 17:00

Zeitplan - EWU-C-Turnier I/24 Niedertaufkirchen

13.07.2024

Gr. Reithalle

09:00	-	09:20	LK 4/5 Showmanship at Halter	Nennungen: 4
09:20	-	09:35	LK 3 Showmanship at Halter	Nennungen: 5
09:35	-	09:50	LK 1/2 Showmanship at Halter - OBB-Meisterschaft	Nennungen: 4
09:50	-	10:05	Walk Trot Pleasure	Nennungen: 4
10:05	-	10:30	Greenhorse Pleasure	Nennungen: 9
10:30	-	10:55	LK 4/5A Western Pleasure	Nennungen: 11
10:55	-	11:10	LK 4/5B Western Pleasure	Nennungen: 4
11:10	-	11:45	LK 1-3 Western Pleasure	Nennungen: 13
11:45	-	12:05	Z LK 1/2 Western Pleasure - OBB-Meisterschaft	Nennungen: 7
12:05	-	12:35	Pause	
12:35	-	12:50	Walk Trot Horsemanship	Nennungen: 5
12:50	-	13:20	Greenhorse Horsemanship	Nennungen: 10
13:20	-	13:40	LK 1/2 Western Horsemanship	Nennungen: 6
13:40	-	14:10	LK 4/5A Western Horsemanship	Nennungen: 11
14:10	-	14:25	LK 4B Western Horsemanship	Nennungen: 4
14:25	-	14:40	LK 5B Western Horsemanship	Nennungen: 4
14:40	-	15:15	LK 3 Western Horsemanship	Nennungen: 11
15:15	-	15:35	Z LK 1/2 Western Horsemanship - OBB-Meisterschaft	Nennungen: 7
15:35	-	16:00	LK 4 Reining	Nennungen: 5
16:00	-	16:45	LK 1-3 Reining	Nennungen: 9
16:45	-	17:20	Z LK 1/2 Reining - OBB-Meisterschaft	Nennungen: 7

14.07.2024

Gr. Reithalle

08:00	-	08:15	Walk Trot Trail	Nennungen: 5
08:15	-	08:30	Führzügel Trail	Nennungen: 5
08:30	-	09:00	Greenhorse Trail	Nennungen: 10
09:00	-	09:30	LK 1/2 Trail	Nennungen: 9
09:30	-	10:05	LK 3 Trail	Nennungen: 15
10:05	-	10:50	LK 4/5A Trail	Nennungen: 16
10:50	-	11:20	LK 4/5B Trail	Nennungen: 9
11:20	-	11:50	Z LK 1/2 Trail - OBB-Meisterschaft	Nennungen: 12
11:50	-	12:20	Pause	
12:20	-	12:30	Walk Trot Ranch Riding	Nennungen: 5
anschl.			Greenhorse Ranch Riding	Nennungen: 16
anschl.			LK 4A Ranch Riding - Sherwood 3R-Cup 2024	Nennungen: 12
anschl.			LK 4B Ranch Riding - Sherwood 3R-Cup 2024	Nennungen: 7
anschl.			LK 5 Ranch Riding	Nennungen: 4
anschl.			LK 1/2 Ranch Riding	Nennungen: 15
anschl.			LK 3A Ranch Riding - Sherwood 3R-Cup 2024	Nennungen: 11
anschl.			LK 3B Ranch Riding - Sherwood 3R-Cup 2024	Nennungen: 5
anschl.			Z LK 1/2 Ranch Riding - OBB-Meisterschaft	Nennungen: 17
anschl.			LK 4A Western Ranch Rail - Sherwood 3R-Cup 2024	Nennungen: 8
anschl.			LK 4B Western Ranch Rail - Sherwood 3R-Cup 2024	Nennungen: 6
anschl.			LK 1/2 Western Ranch Rail	Nennungen: 10
anschl.			LK 3 Western Ranch Rail	Nennungen: 14
anschl.			Z LK 1/2 Western Ranch Rail - OBB-Meisterschaft	Nennungen: 11

Unser Hauptsponsor

- bei diesem Turnier leider nicht vor Ort -
*** aber im Oktober wieder dabei ***



alex mundorff
western riding & country lifestyle



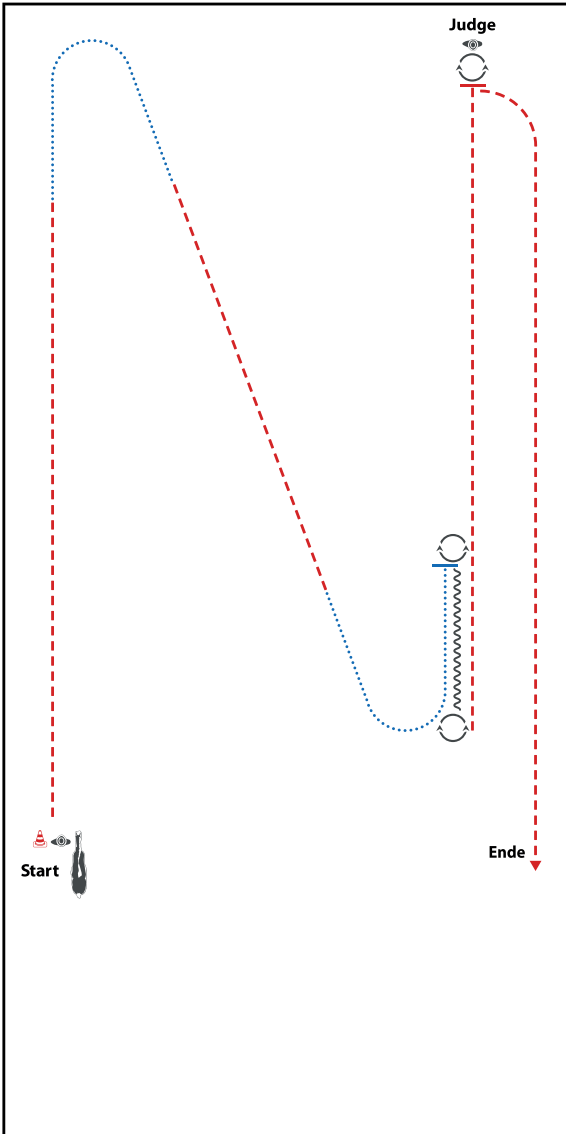

BE READY AT MARKER

- 1) TROT, WALK
- 2) TROT, WALK, STOP
- 3) TURN 360°
- 4) BACK UP
- 5) TURN 360°
- 6) TROT, STOP
- 7) SET UP
- 8) INSPECTION
- 9) TURN 90°, TROT
TROT OUT

WALK (SCHRITT)
EXTENDED WALK
JOG/TROT (TRAB)	-----
EXTENDED TROT	-----
LOPE (GALOPP)	=====
EXTENDED LOPE	=====
BACK UP (RÜCKWÄRTS)	~~~~~
LEAD CHANGE (GALOPPWECHSEL)	=====
TURN (DREHUNG)	⤿

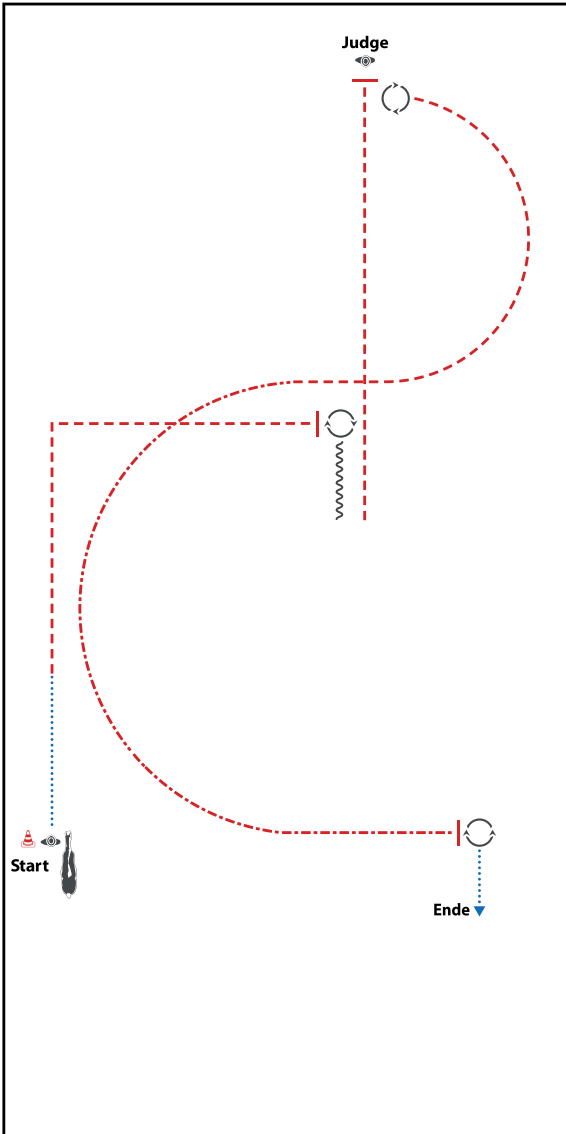

BE READY AT MARKER

- 1) WALK, TROT CORNER
- 2) STOP, TURN 270°
- 3) BACK UP (AT LEAST ONE HORSE LENGTH)
- 4) TROT, STOP
- 5) SET UP
- 6) INSPECTION
- 7) TURN 450°
- 8) TROT
- 9) EXTENDED TROT
- 10) STOP, TURN 450°, WALK OUT

WALK (SCHRITT)
EXTENDED WALK
JOG/TROT (TRAB)	-----
EXTENDED TROT	-----
LOPE (GALOPP)	=====
EXTENDED LOPE	=====
BACK UP (RÜCKWÄRTS)	~~~~~
LEAD CHANGE (GALOPPWECHSEL)	=====
TURN (DREHUNG)	⤵

Beim Turnier mit Verkaufsstand vor Ort:



Showoutfits für...

Kids, Teens & Erwachsene,

Leadline Klassen, DIY-Oberteile,

Mutter/Tochter Kombinationen und

Jungen Hemden

Showoutfit-Schnittmuster für...

Mädchen & Damen

Westernaccessoire & Turnierhelfer

WWW.SHOWYOU.DE INFO@SHOWYOU.DE

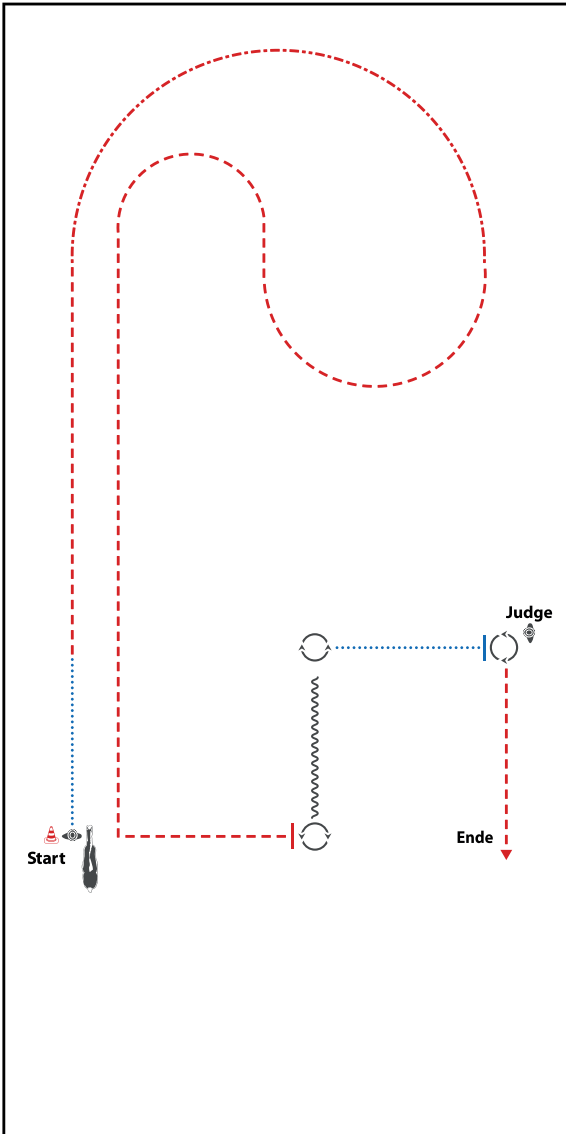

BE READY AT MARKER

- 1) WALK, TROT
- 2) EXTENDED TROT
- 3) TROT SERPENTIN AND TROT CORNER, STOP
- 4) TURN 45°
- 5) BACK UP
- 6) TURN 630°, WALK, STOP
- 7) SET UP
- 8) INSPECTION
- 9) TURN 90°, TROT
TROT OUT

WALK (SCHRITT)
EXTENDED WALK
JOG/TROT (TRAB)
EXTENDED TROT
LOPE (GALOPP)	=====
EXTENDED LOPE	=====
BACK UP (RÜCKWÄRTS)	~~~~~
LEAD CHANGE (GALOPPWECHSEL)	=====
TURN (DREHUNG)	⊙

Walk Trot Horsemanship

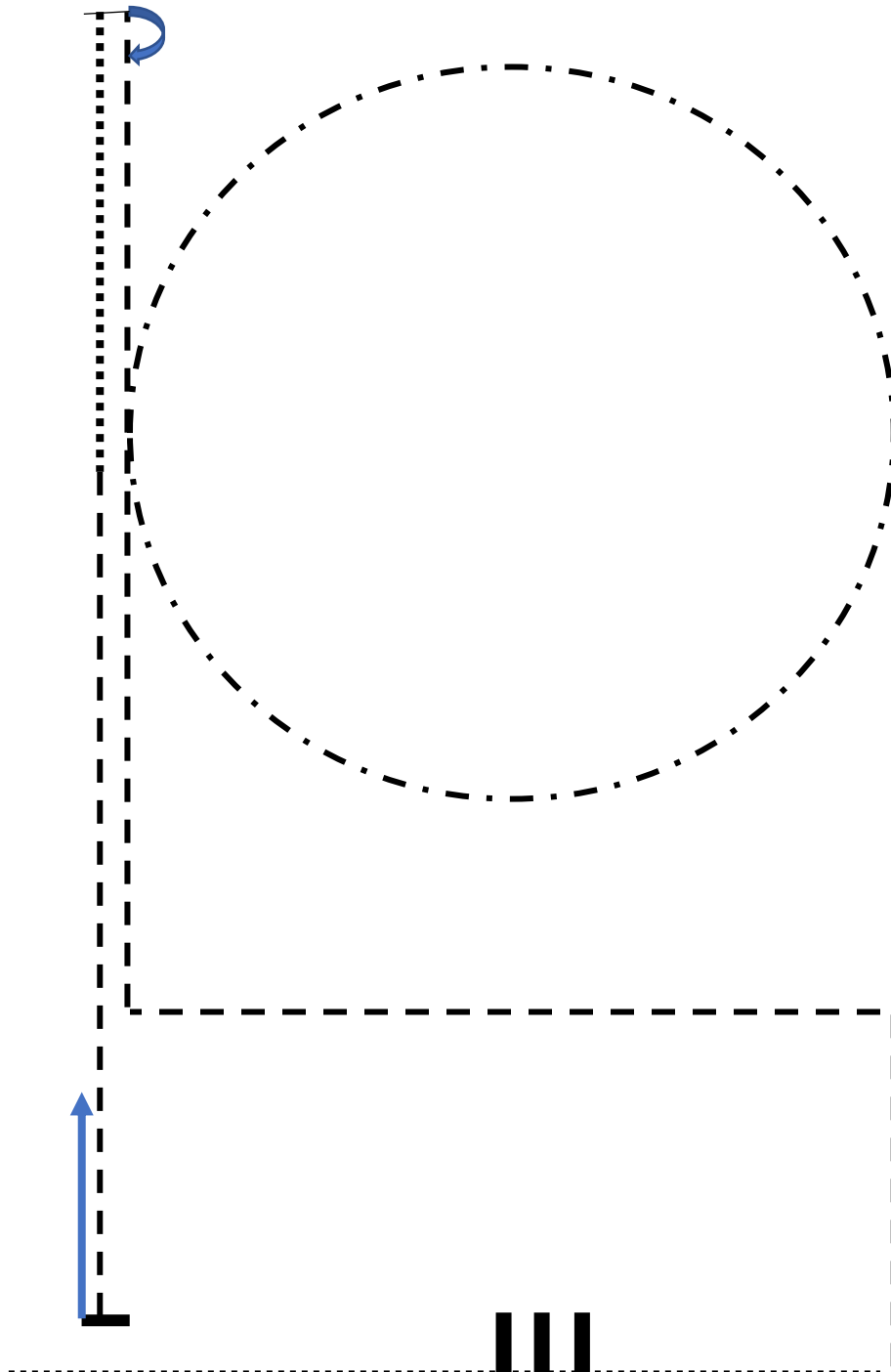

1. Walk – Walk over
2. Trot corner
3. Extended Trot Circle - Trot
4. Stop – Turn **180°**
5. Walk – Tot
6. Stop – Back Up



www.carat-automaten.de

Alles rund ums Pferd
www.RASP-Online.de



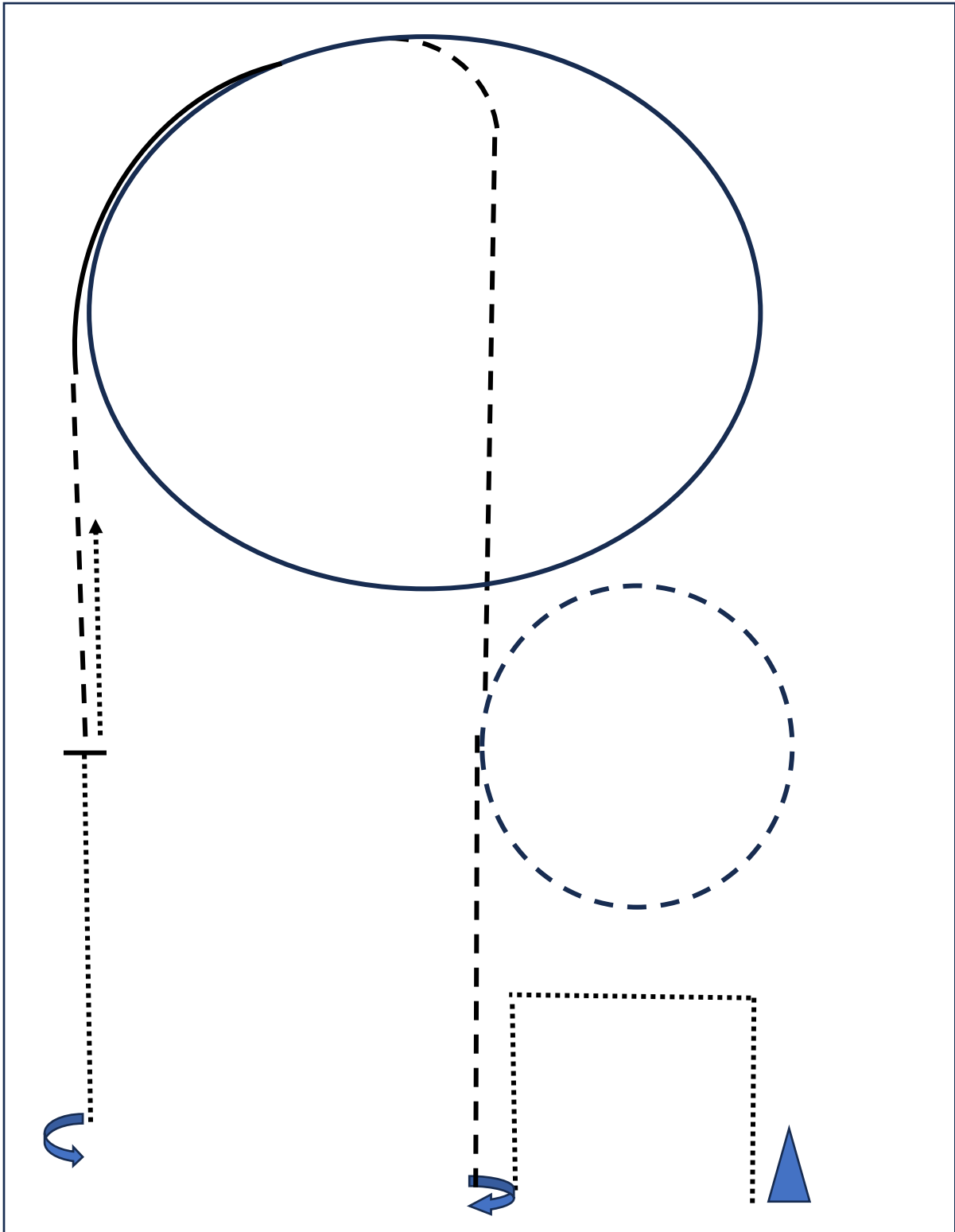

1. Be ready at Pylone – walk corners
2. Turn 180° right
3. Jog small circle – straight on
4. Lope big circle left lead
5. Jog – stop back up
6. Walk – Turn 360° left – leave arena

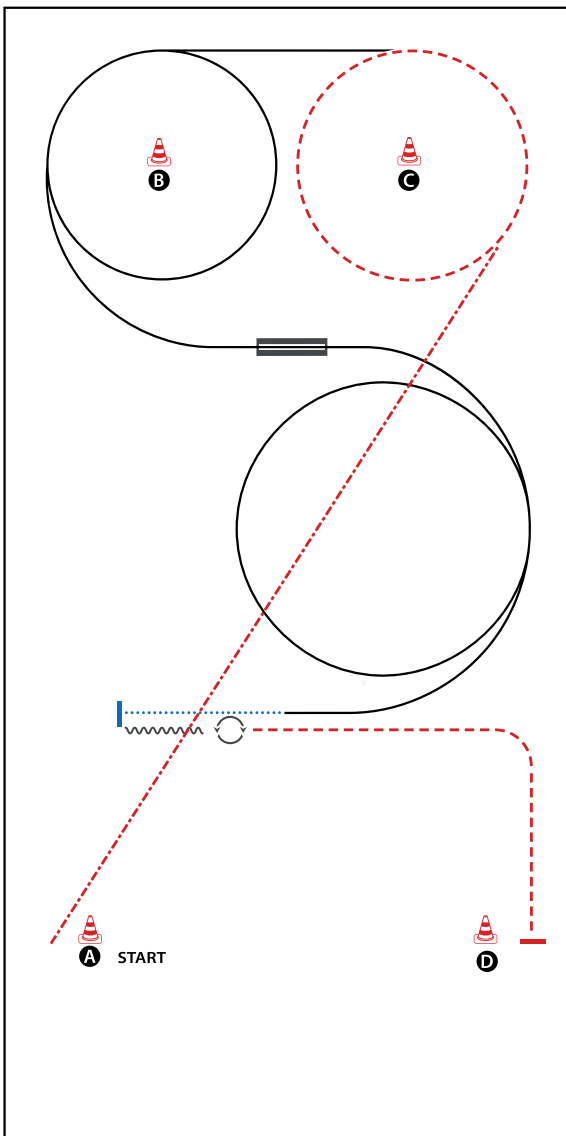

BE READY AT A

- 1) EXTENDED JOG
- 2) JOG
- 3) LOPE (LL)
- 4) CHANGE LEADS (SIMPLE OR FLYING)
- 5) LOPE (RL)
- 6) WALK
- 7) STOP, BACK UP (AT LEAST ONE HORSE LENGTH)
- 8) TURN 540° (LEFT OR RIGHT)
- 9) JOG, STOP
WALK OUT

WALK (SCHRITT)	
EXTENDED WALK	
JOG/TROT (TRAB)	
EXTENDED TROT	
LOPE (GALOPP)	
EXTENDED LOPE	
BACK UP (RÜCKWÄRTS)	
LEAD CHANGE (GALOPPWECHSEL)	
TURN (DREHUNG)	

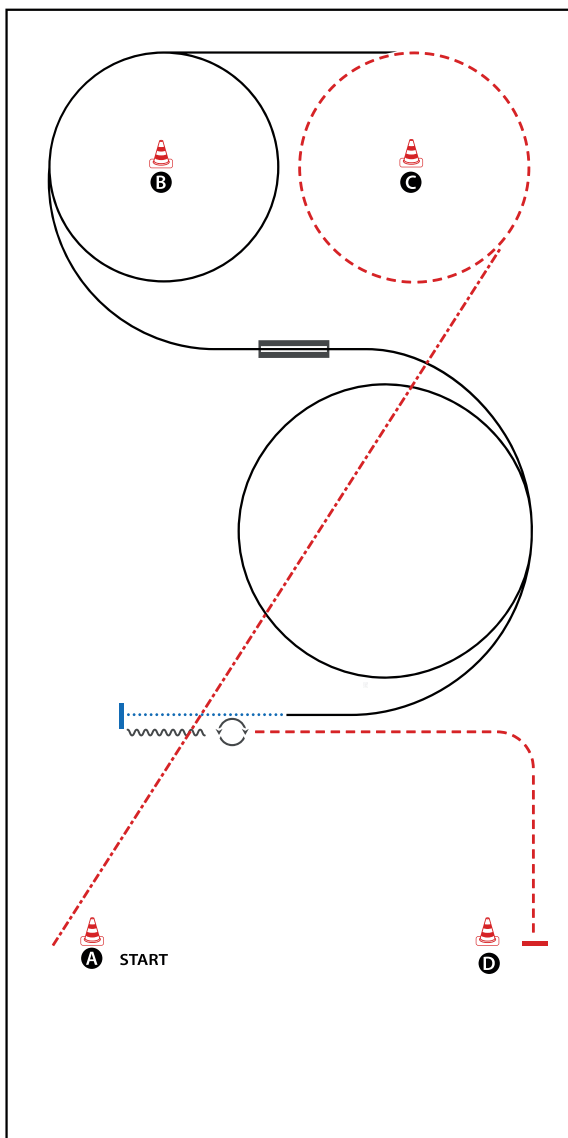

BE READY AT A

- 1) EXTENDED JOG
- 2) JOG
- 3) LOPE (LL)
- 4) CHANGE LEADS (SIMPLE OR FLYING)
- 5) LOPE (RL)
- 6) WALK
- 7) STOP, BACK UP (AT LEAST ONE HORSE LENGTH)
- 8) TURN 540° (LEFT OR RIGHT)
- 9) JOG, STOP
WALK OUT

WALK (SCHRITT)	
EXTENDED WALK	
JOG/TROT (TRAB)	
EXTENDED TROT	
LOPE (GALOPP)	
EXTENDED LOPE	
BACK UP (RÜCKWÄRTS)	
LEAD CHANGE (GALOPPWECHSEL)	
TURN (DREHUNG)	

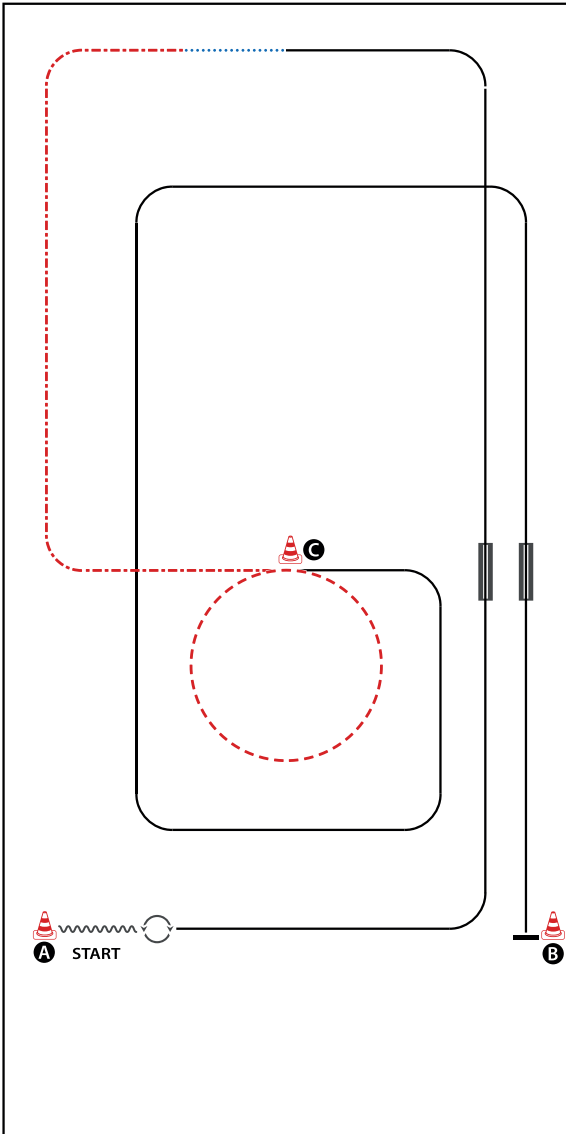

BE READY AT A

- 1) (MARKER IN FRONT OF YOUR HORSE),
BACK UP (AT LEAST ONE HORSE LENGTH)
- 2) TURN 540° (LEFT OR RIGHT)
- 3) LOPE (LL)
- 4) CHANGE LEADS (SIMPLE OR FLYING)
- 5) LOPE (RL)
- 6) WALK
- 7) EXTENDED JOG
- 8) JOG
- 9) LOPE (RL)
- 10) CHANGE LEADS (SIMPLE OR FLYING), LOPE (LL), STOP
WALK OUT

WALK (SCHRITT)	
EXTENDED WALK	
JOG/TROT (TRAB)	
EXTENDED TROT	
LOPE (GALOPP)	
EXTENDED LOPE	
BACK UP (RÜCKWÄRTS)	
LEAD CHANGE (GALOPPWECHSEL)	
TURN (DREHUNG)	

Reining Pattern 15 (nur für LK 4)

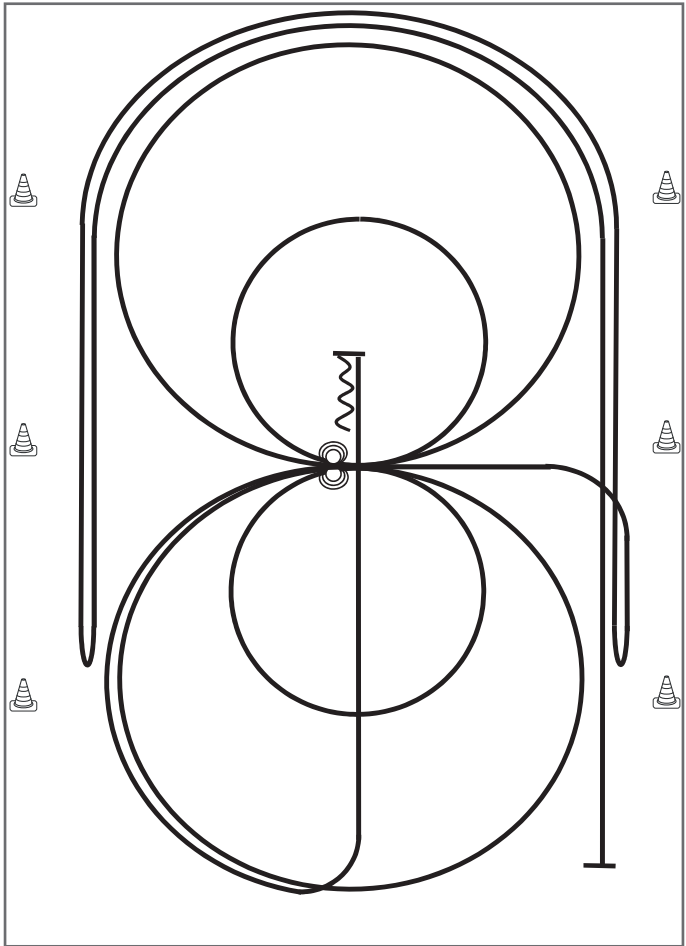

- 1) Galopp mind. 6,00 m von der Bande entfernt, (**links**) auf dem Zirkel, der nicht geschlossen wird, Run Down entlang der langen Seite, Stop mind. 6,00 m von der Bande entfernt hinter dem **Mittelmarker**, Rollback **rechts**, kein Verharren
- 2) Galopp, (**rechts**) auf dem Zirkel, der nicht geschlossen wird, Run Down entlang der langen Seite, Stop mind. 6,00 m von der Bande entfernt hinter dem **Mittelmarker**, Rollback **links**, kein Verharren, Galopp zu X
- 3) 2 Zirkel Galopp (**links**), 1. groß und schnell, **2. klein** und langsam, Stop bei X
- 4) 3 Spins **links**, Verharren
- 5) 2 Zirkel Galopp (**rechts**), 1. groß und schnell, **2. klein** und langsam, Stop bei X
- 6) 3 Spins **rechts**, Verharren
- 7) Galopp (**links**) auf dem Zirkel, der nicht geschlossen wird, Run Down auf der Mittellinie, Stop hinter dem **Mittelmarker**
- 8) Rückwärtsrichten mind. 3,00 m, Verharren

Trab	-----
Galopp	—————
Rückwärts	~~~~~

Der Reiter muss das Kopfstück zur Gebisskontrolle vor dem Richter abnehmen.

Reining Pattern 6

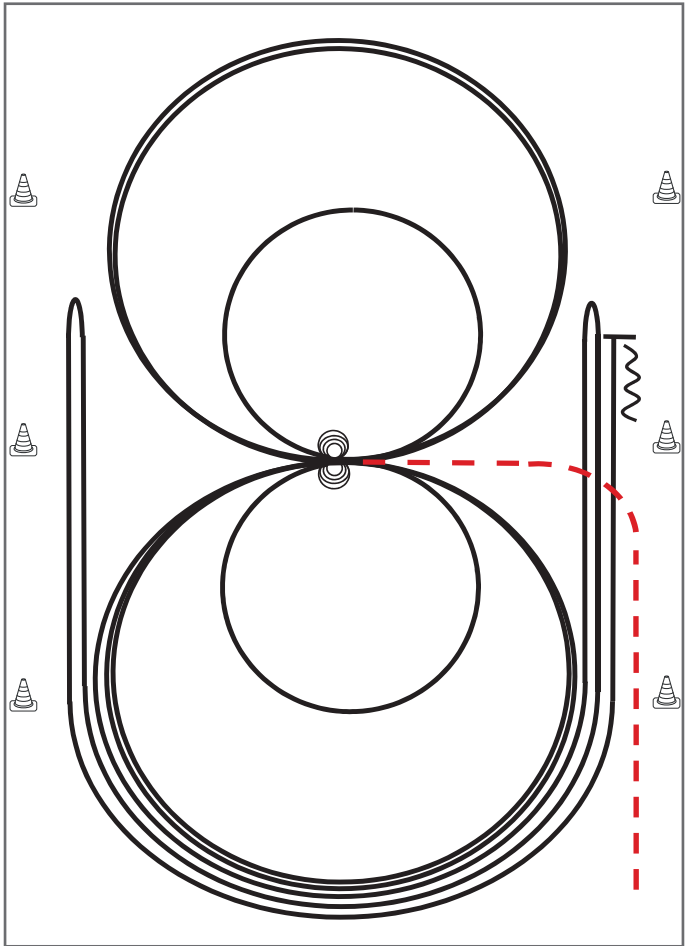

Im Trab zur Mitte der Bahn. Beginn der Aufgabe aus dem Schritt oder aus dem Stand.

- 1) 4 Spins **rechts**, Verharren
- 2) 4 Spins **links**, Verharren
- 3) 3 Zirkel Galopp (**links**), 1. + 2. groß und schnell, **3. klein** und langsam, Galoppwechsel bei X
- 4) 3 Zirkel Galopp (**rechts**), 1. + 2. groß und schnell, **3. klein** und langsam, Galoppwechsel bei X
- 5) Galopp (**links**) auf dem Zirkel, der nicht geschlossen wird, Run Down entlang der langen Seite, Sliding Stop mind. 6,00 m von der Bande entfernt hinter dem **Mittelmarker**, Rollback **rechts**, kein Verharren
- 6) Galopp (**rechts**) auf dem Zirkel, der nicht geschlossen wird, Run Down entlang der langen Seite, Sliding Stop mind. 6,00 m von der Bande entfernt hinter dem **Mittelmarker**, Rollback **links**, kein Verharren
- 7) Galopp (**links**) auf dem Zirkel, der nicht geschlossen wird, Run Down entlang der langen Seite, Sliding Stop mind. 6,00 m von der Bande entfernt hinter dem **Mittelmarker**, Rückwärtsrichten mind. 3,00 m, Verharren

Der Reiter muss das Kopfstück zur Gebisskontrolle vor dem Richter abnehmen.

Trab	-----
Galopp	—————
Rückwärts	~~~~~

Reining Pattern 4

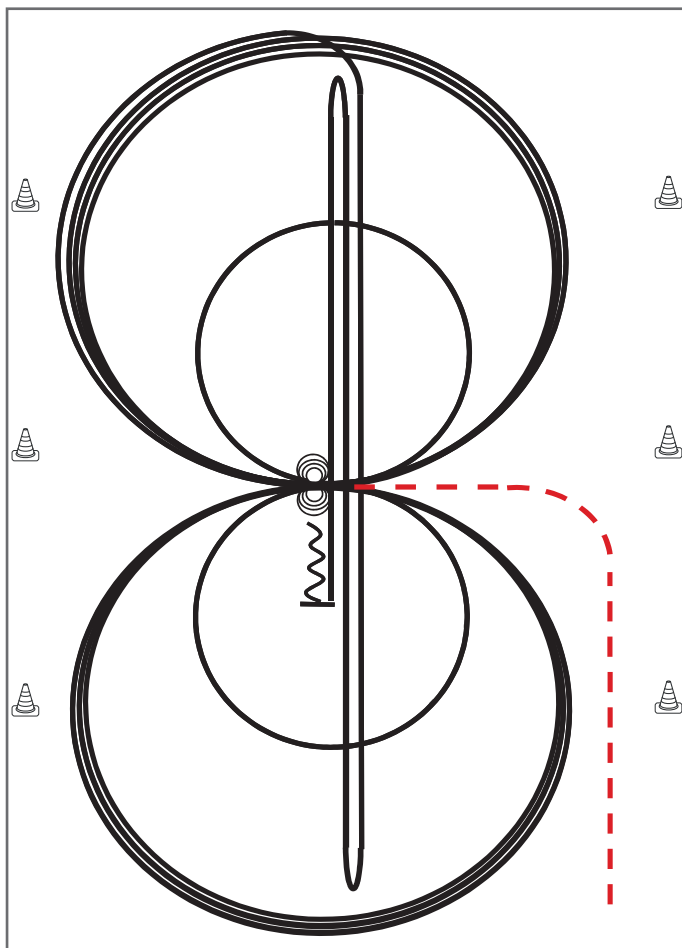

Im Trab zur Mitte der Bahn.

Beginn der Aufgabe aus dem Schritt oder aus dem Stand.

- 1) 3 Zirkel Galopp (**rechts**), 1. + 2. groß und schnell, **3. klein** und langsam, Stop bei X
 - 2) 4 Spins rechts, Verharren
 - 3) 3 Zirkel Galopp (**links**), 1. + 2. groß und schnell, **3. klein** und langsam, Stop bei X
 - 4) 4 Spins **links**, Verharren
 - 5) 1 Zirkel Galopp (**rechts**) groß und schnell, Galoppwechsel bei X, 1 Zirkel Galopp (**links**) groß und schnell, Galoppwechsel bei X (figure 8)
 - 6) Galopp (**rechts**) auf dem Zirkel, der nicht geschlossen wird, Run Down auf der Mittellinie, Sliding Stop hinter dem **Endmarker**, Rollback **rechts**, kein Verharren
 - 7) Run Down auf der Mittellinie, Sliding Stop hinter dem **Endmarker**, Rollback **links**, kein Verharren
 - 8) Run Down auf der Mittellinie, Sliding Stop hinter dem **Mittelmarker**, Rückwärtsrichten bis zur Mitte der Bahn oder mind. 3,00 m, Verharren
- Der Reiter muss das Kopfstück zur Gebisskontrolle vor dem Richter abnehmen.

Trab	-----
Galopp	—————
Rückwärts	~~~~~

A[®] BERUFSKLEIDUNG USWEGER -TEXTILSTICKEREI-

Rennbahnstraße 3

84323 Massing

Tel. 08724/1750

www.ausweger.de

ausweger@t-online.de

Fax 08724/8324

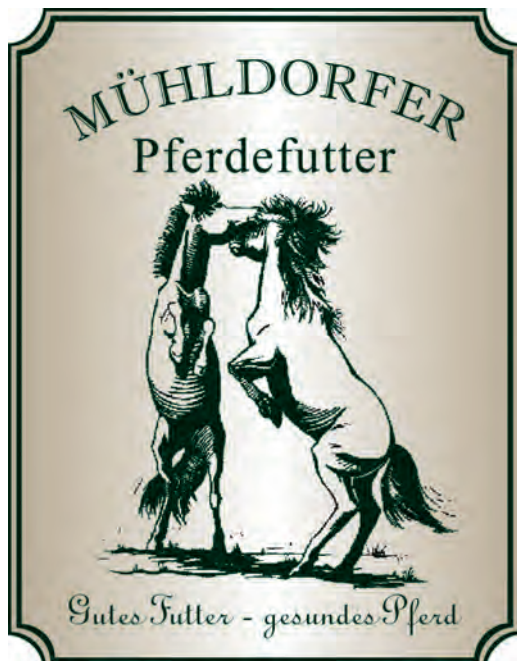

www.Muehdorfer-Pferdefutter.de

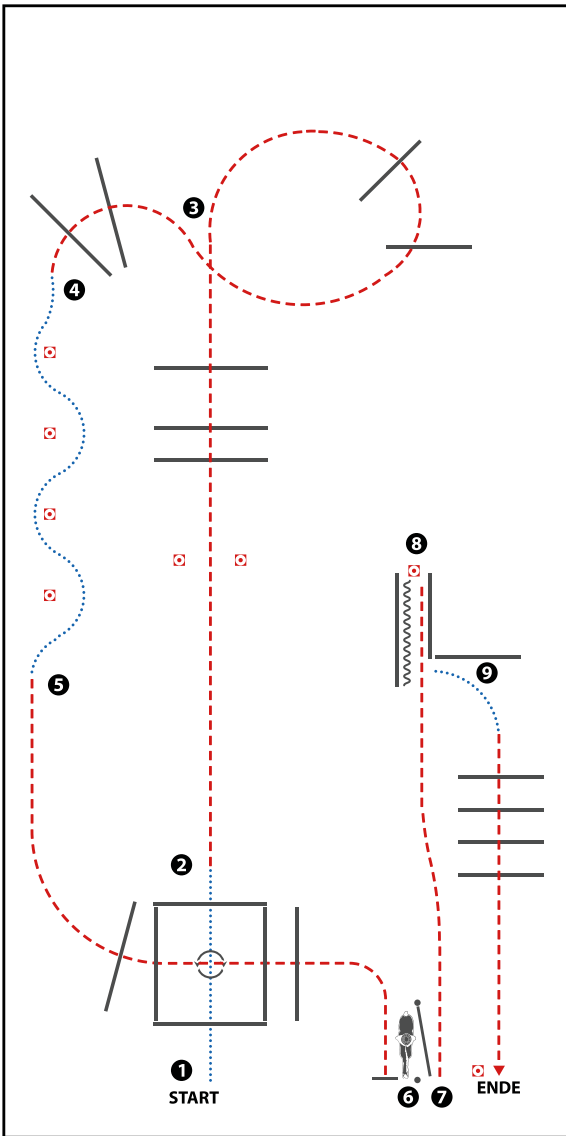

- 1) WALK INTO BOX, 360° TURN EITHER WAY, WALK OUT
(Im Schritt in die Box, 360° Wendung rechts oder links, im Schritt aus der Box)
- 2) JOG OVER (Trabstangen)
- 3) JOG OVER (Trabstangen)
- 4) WALK SERPENTINE (Schritt Slalom)
- 5) JOG OVER (Trabstangen)
- 6) GATE LH (Tor linke Hand)
- 7) JOG INTO CHUTE (Trab in die Gasse)
- 8) BACK UP, TURN RIGHT (Rückwärts, nach rechts abwenden)
- 9) WALK, JOG OVER (Schritt, Trabstangen)

WALK (SCHRITT)
EXTENDED WALK
JOG/TROT (TRAB)	-----
EXTENDED TROT	-----
LOPE (GALOPP)	=====
EXTENDED LOPE	=====
BACK UP (RÜCKWÄRTS)	~~~~~
LEAD CHANGE (GALOPPWECHSEL)	=====
TURN (DREHUNG)	⊙

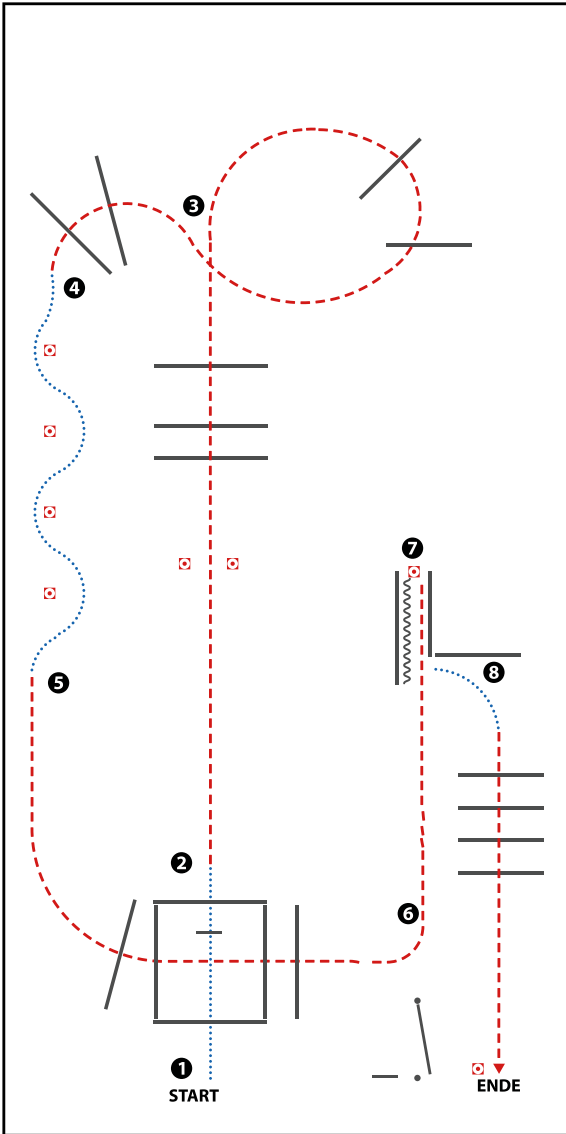

1) WALK INTO BOX, STOP, WALK OUT
(Im Schritt in die Box, anhalten, im Schritt aus der Box)

2) JOG OVER (Trabstangen)

3) JOG OVER (Trabstangen)

4) WALK SERPENTINE (Schritt Slalom)

5) JOG OVER (Trabstangen)

6) JOG INTO CHUTE (Trab in die Gasse)

7) BACK UP, TURN RIGHT (Rückwärts, nach rechts abwenden)

8) WALK, JOG OVER (Schritt, Trabstangen)

WALK (SCHRITT)
EXTENDED WALK
JOG/TROT (TRAB)	-----
EXTENDED TROT	-----
LOPE (GALOPP)	=====
EXTENDED LOPE	=====
BACK UP (RÜCKWÄRTS)	~~~~~
LEAD CHANGE (GALOPPWECHSEL)	=====
TURN (DREHUNG)	⤵

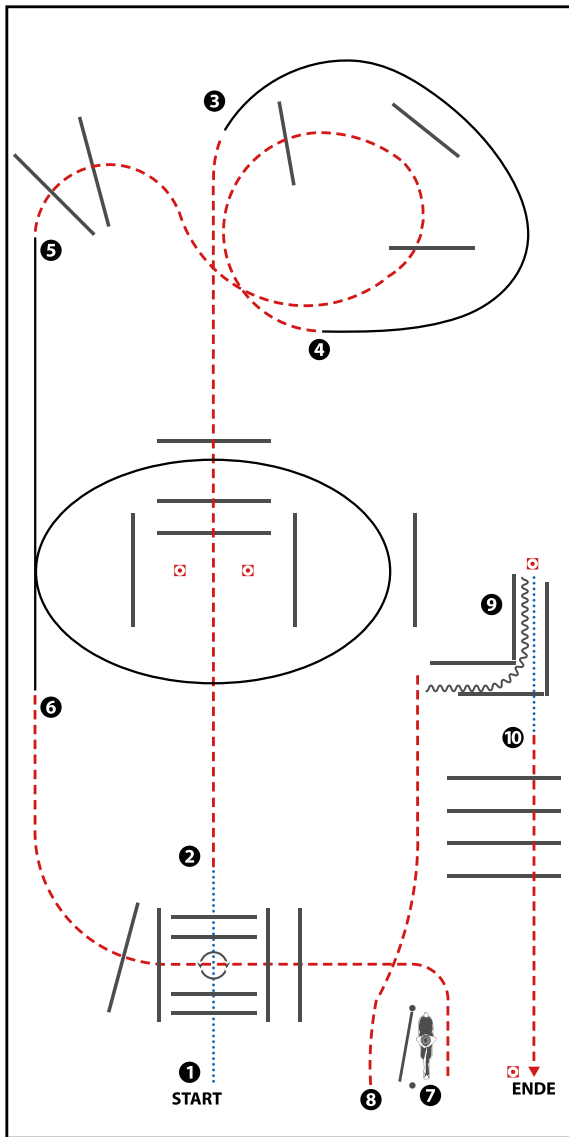

- 1) WALK OVER INTO BOX, 360° TURN LEFT or RIGHT, WALK OUT
- 2) JOG OVER
- 3) LOPE (RL)
- 4) JOG OVER
- 5) LOPE (LL)
- 6) JOG OVER
- 7) GATE RH
- 8) JOG, 90° TURN LEFT
- 9) BACK UP, WALK OUT
- 10) JOG OVER

WALK (SCHRITT)
EXTENDED WALK
JOG/TROT (TRAB)	-----
EXTENDED TROT	-----
LOPE (GALOPP)	=====
EXTENDED LOPE	=====
BACK UP (RÜCKWÄRTS)	~~~~~
LEAD CHANGE (GALOPPWECHSEL)	=====
TURN (DREHUNG)	⊙

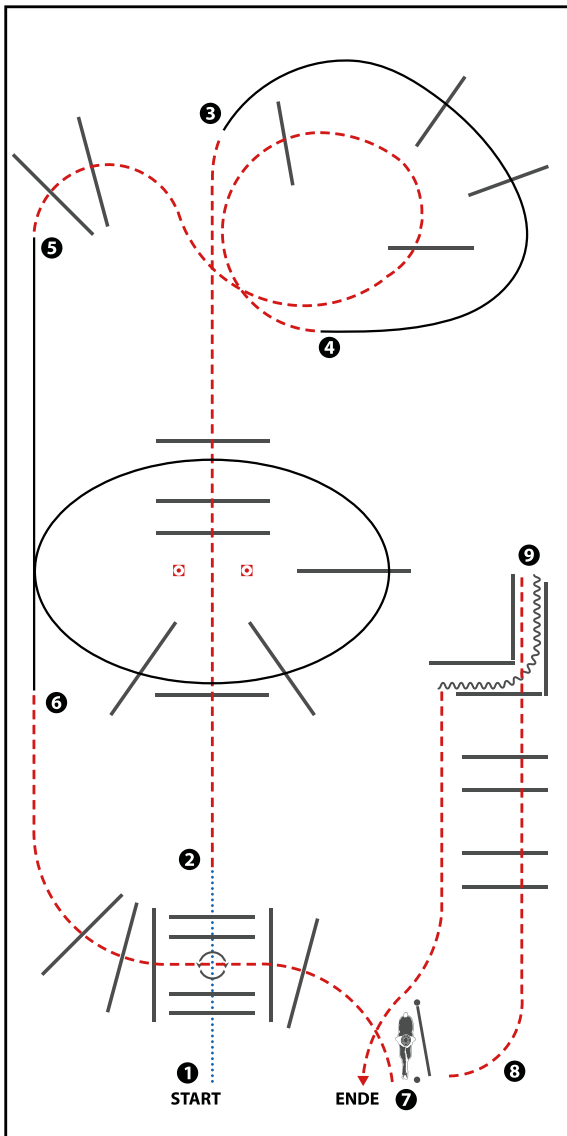

- 1) WALK OVER INTO BOX, 360° TURN EACH DIRECTION, WALK OUT
- 2) JOG OVER
- 3) LOPE OVER (RL)
- 4) JOG OVER
- 5) LOPE OVER (LL)
- 6) JOG OVER
- 7) GATE LH
- 8) EXTENDED JOG OVER POLES AND INTO CHUTE
- 9) BACK UP, 90° TURN RIGHT, JOG OUT

WALK (SCHRITT)
EXTENDED WALK
JOG/TROT (TRAB)	-----
EXTENDED TROT	-----
LOPE (GALOPP)	=====
EXTENDED LOPE	=====
BACK UP (RÜCKWÄRTS)	~~~~~
LEAD CHANGE (GALOPPWECHSEL)	=====
TURN (DREHUNG)	

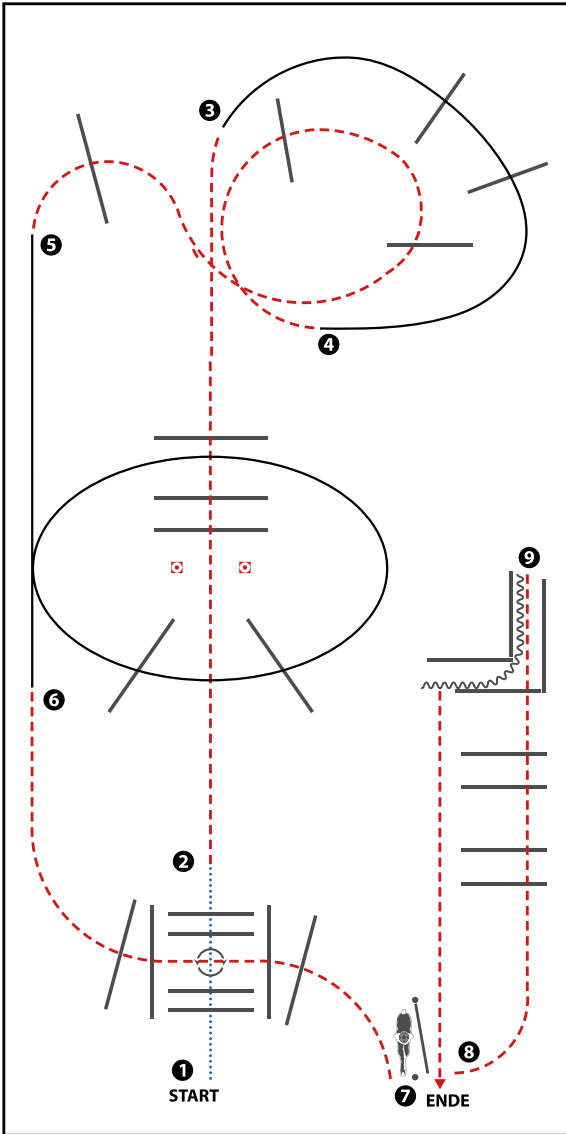

- 1) WALK OVER INTO BOX, 360° TURN EACH DIRECTION, WALK OUT
- 2) JOG OVER
- 3) LOPE OVER (RL)
- 4) JOG OVER
- 5) LOPE OVER (LL)
- 6) JOG OVER
- 7) GATE LH
- 8) JOG OVER POLES AND INTO CHUTE
- 9) BACK UP, 90° TURN RIGHT, JOG OUT

WALK (SCHRITT)
EXTENDED WALK
JOG/TROT (TRAB)
EXTENDED TROT
LOPE (GALOPP)
EXTENDED LOPE
BACK UP (RÜCKWÄRTS)	~~~~~
LEAD CHANGE (GALOPPWECHSEL)	=====
TURN (DREHUNG)	

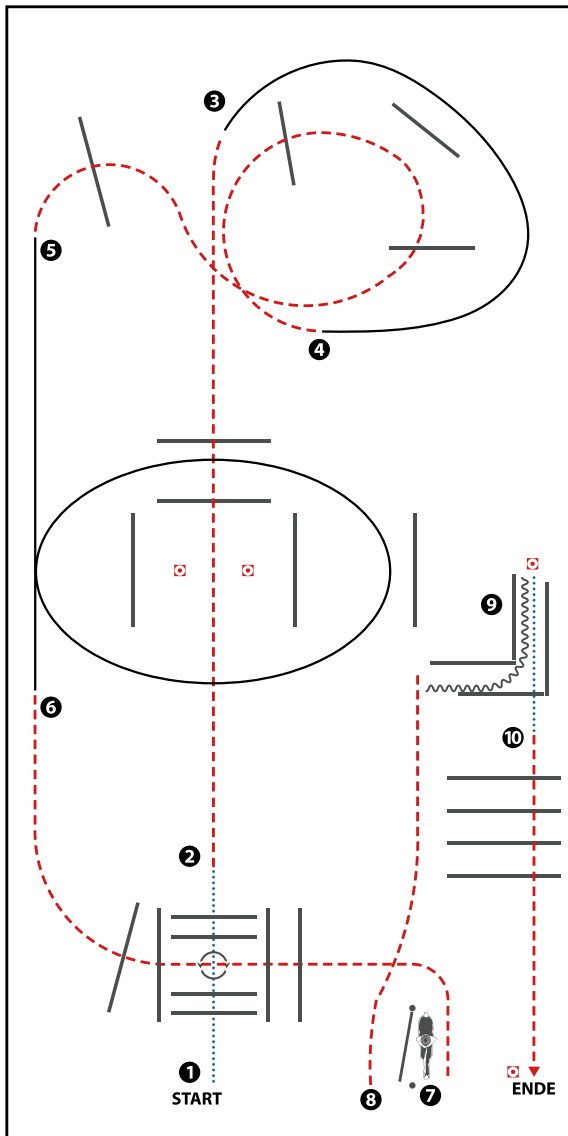

- 1) WALK OVER INTO BOX, 360° TURN LEFT or RIGHT, WALK OUT
- 2) JOG OVER
- 3) LOPE (RL)
- 4) JOG OVER
- 5) LOPE (LL)
- 6) JOG OVER
- 7) GATE RH
- 8) JOG, 90° TURN LEFT
- 9) BACK UP, WALK OUT
- 10) JOG OVER

WALK (SCHRITT)
EXTENDED WALK
JOG/TROT (TRAB)	-----
EXTENDED TROT	-----
LOPE (GALOPP)	=====
EXTENDED LOPE	=====
BACK UP (RÜCKWÄRTS)	~~~~~
LEAD CHANGE (GALOPPWECHSEL)	=====
TURN (DREHUNG)	

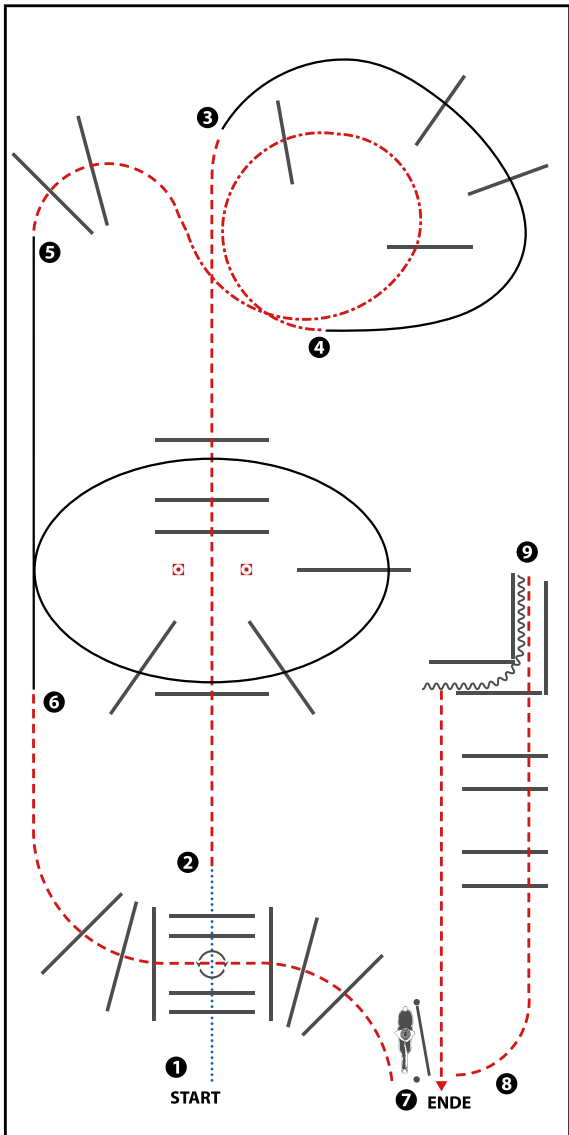

- 1) WALK OVER INTO BOX, 360° TURN EACH DIRECTION, WALK OUT
- 2) JOG OVER
- 3) LOPE OVER (RL)
- 4) EXTENDED JOG OVER 2 POLES, JOG OVER 2 POLES
- 5) LOPE OVER (LL)
- 6) JOG OVER
- 7) GATE LH
- 8) JOG OVER POLES AND INTO CHUTE
- 9) BACK UP, 90° TURN RIGHT, JOG OUT

WALK (SCHRITT)
EXTENDED WALK
JOG/TROT (TRAB)	-----
EXTENDED TROT	-----
LOPE (GALOPP)	=====
EXTENDED LOPE	=====
BACK UP (RÜCKWÄRTS)	~~~~~
LEAD CHANGE (GALOPPWECHSEL)	=====
TURN (DREHUNG)	



Pferdepension ~ Guest-Ranch

Josef Fuchs
Pferdewirtschaftsmeister



~ Pferdepension ~

Alle Haltungsformen - Westernreitunterricht - Beritt
Wanderreitstation - Urlaubsranch mit und ohne Pferd



Hinteralbing 1

84494 Niedertaufkirchen

Mobil: +49.(0)172.8139739

Tel.: +49.(0)8635.693860

Fax: +49.(0)8635.693859

eMail: info@sherwoodranch.de

www.sherwoodranch.de



Walk Trot Ranch Riding

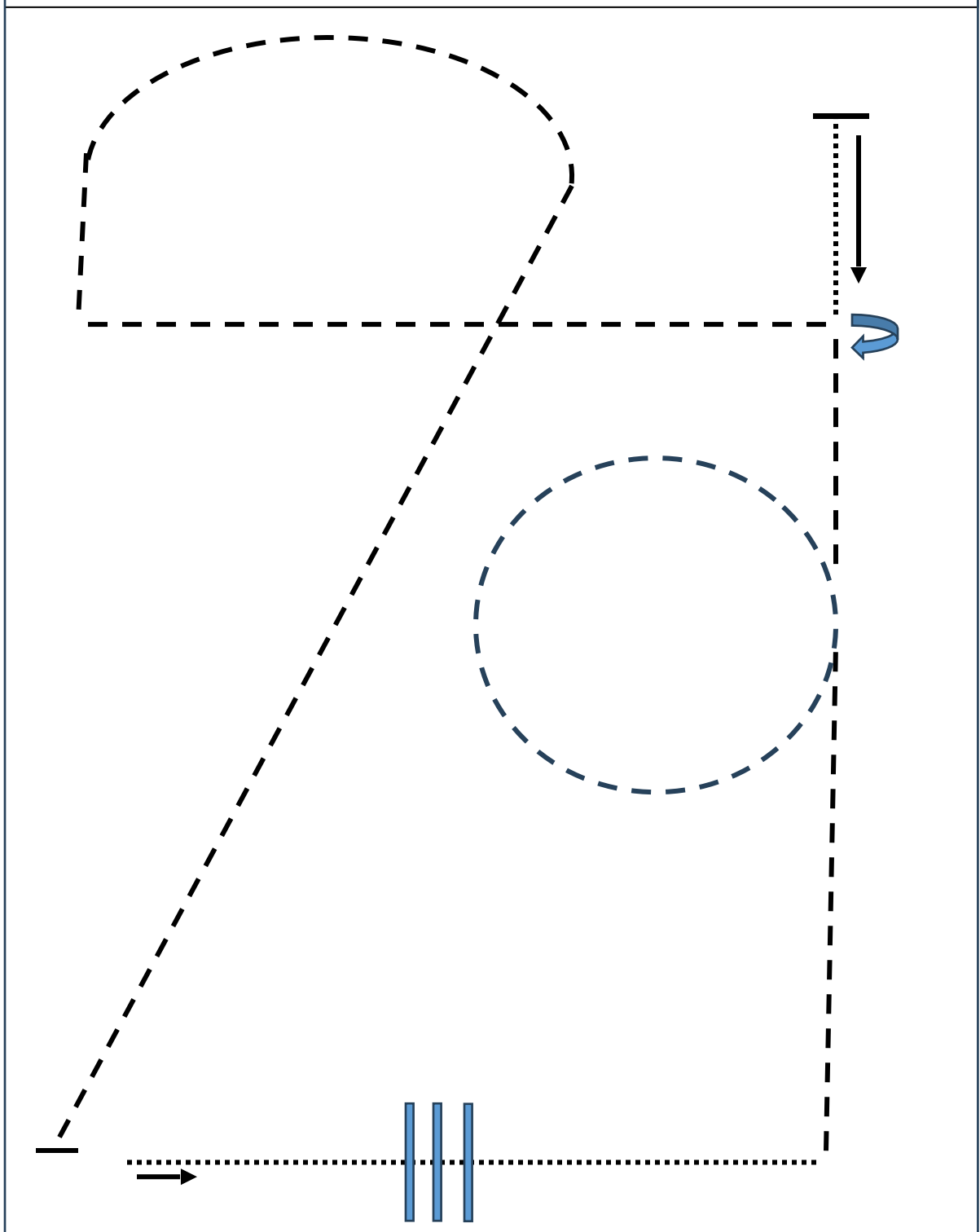

1. Walk , walk over poles
2. Trot straight line
3. Trot small circle left
4. Walk – Stop - back up
5. turn 270° right
6. Trot line, corner and half circle
7. Extended trot and stop

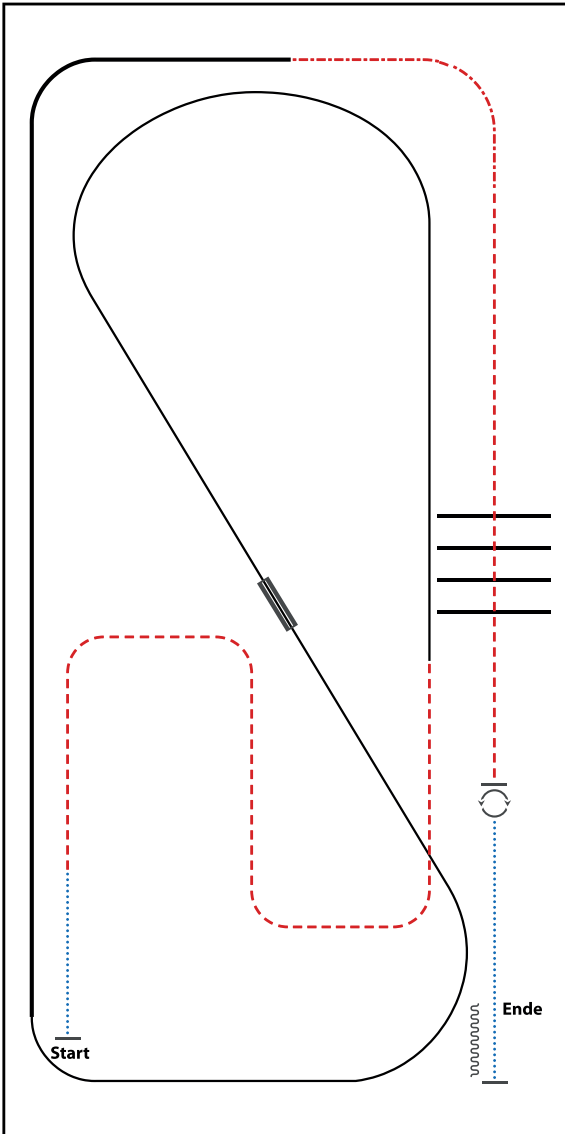

- 1) WALK
- 2) TROT
- 3) LOPE (LL)
- 4) CHANGE LEADS (SIMPLE OR FLYING)
- 5) LOPE (RL)
- 6) EXTENDED LOPE (RL)
- 7) EXTENDED TROT
- 8) TROT
- 9) TROT OVER
- 10) STOP, TURNS 360° (EACH DIRECTION)
- 11) WALK, STOP, BACK UP

WALK (SCHRITT)	
EXTENDED WALK	
JOG/TROT (TRAB)	
EXTENDED TROT	
LOPE (GALOPP)	
EXTENDED LOPE	
BACK UP (RÜCKWÄRTS)	
LEAD CHANGE (GALOPPWECHSEL)	
TURN (DREHUNG)	
	ERSTE
	WESTERWEITER
	UNION
	WEGWEISER/STRASSE WEISWEISUNG

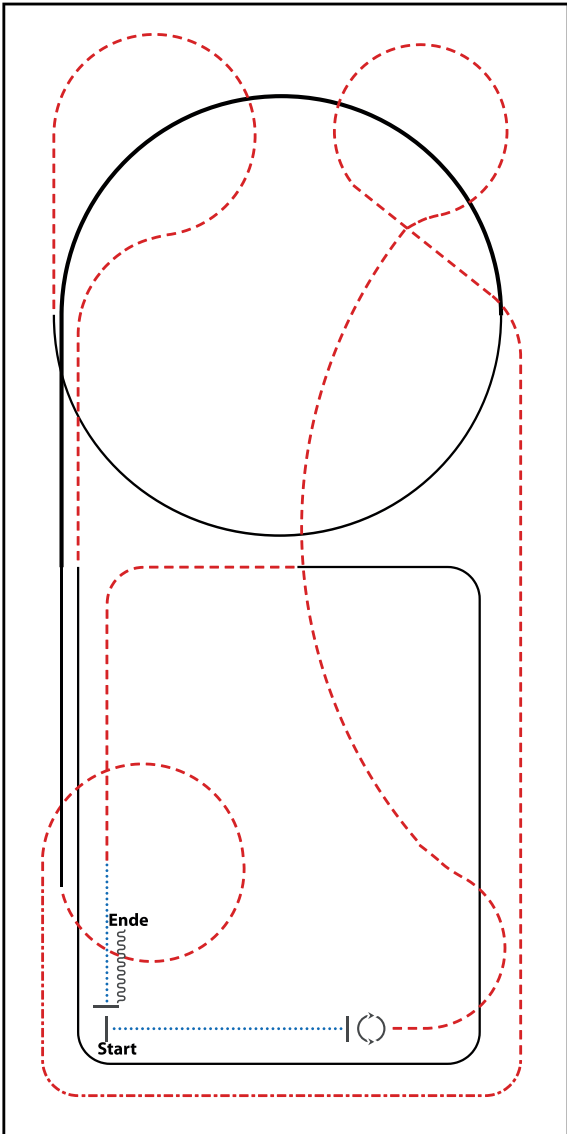

- 1) WALK
- 2) STOP, TURNS 360° (EACH DIRECTION)
- 3) TROT
- 4) EXTENDED TROT, TROT
- 5) LOPE (RL), EXTENDED LOPE (RL), LOPE (RL)
- 6) TROT
- 7) LOPE (LL)
- 8) TROT, WALK
- 9) STOP, BACK UP

WALK (SCHRITT)	
EXTENDED WALK	
JOG/TROT (TRAB)	
EXTENDED TROT	
LOPE (GALOPP)	
EXTENDED LOPE	
BACK UP (RÜCKWÄRTS)	
LEAD CHANGE (GALOPPWECHSEL)	
TURN (DREHUNG)	
	ERSTE
	WESTENREITER
	UNION
	WESTERUNIONREITER

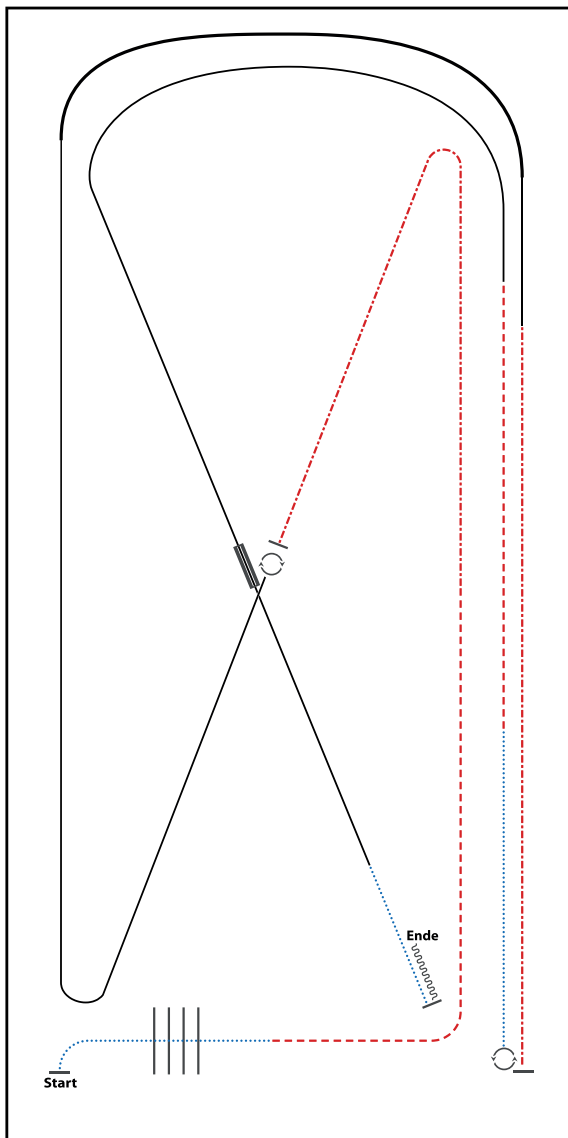

- 1) WALK OVER
- 2) TROT
- 3) EXTENDED TROT
- 4) STOP, 360° TURN RIGHT
- 5) LOPE (RL)
- 6) EXTENDED LOPE (RL), LOPE (RL)
- 7) EXTENDED TROT
- 8) STOP, 540° TURN LEFT
- 9) WALK
- 10) TROT
- 11) LOPE (LL)
- 12) CHANGE LEADS (SIMPLE OR FLYING), LOPE (RL)
- 13) WALK, STOP, BACK UP

WALK (SCHRITT)	
EXTENDED WALK	
JOG/TROT (TRAB)	
EXTENDED TROT	
LOPE (GALOPP)	
EXTENDED LOPE	
BACK UP (RÜCKWÄRTS)	
LEAD CHANGE (GALOPPWECHSEL)	
TURN (DREHUNG)	
	ERSTE
	WESTENREITER
	UNION
	WESTENREITER

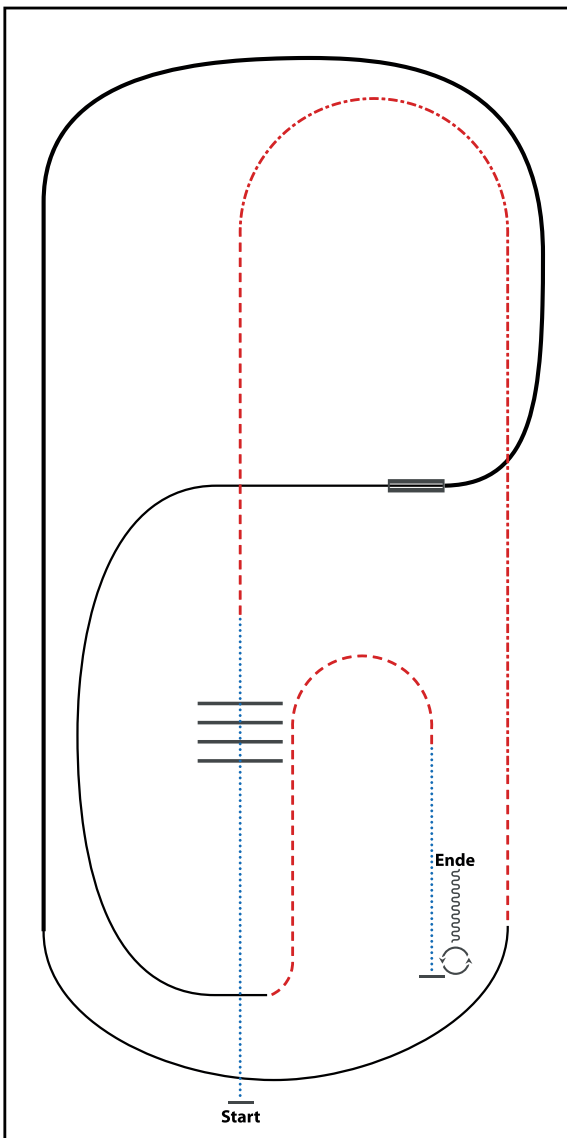

- 1) WALK OVER
- 2) TROT
- 3) EXTENDED TROT, TROT
- 4) LOPE (RL)
- 5) EXTENDED LOPE (RL)
- 6) CHANGE LEADS (SIMPLE OR FLYING)
- 7) LOPE (LL)
- 8) TROT
- 9) WALK
- 10) STOP, TURNS 360° (EACH DIRECTION)
- 11) BACK UP

WALK (SCHRITT)	
EXTENDED WALK	
JOG/TROT (TRAB)	
EXTENDED TROT	
LOPE (GALOPP)	
EXTENDED LOPE	
BACK UP (RÜCKWÄRTS)	
LEAD CHANGE (GALOPPWECHSEL)	
TURN (DREHUNG)	
	ERSTE
	WESTENREITER
	UNION
	WESTENREITER

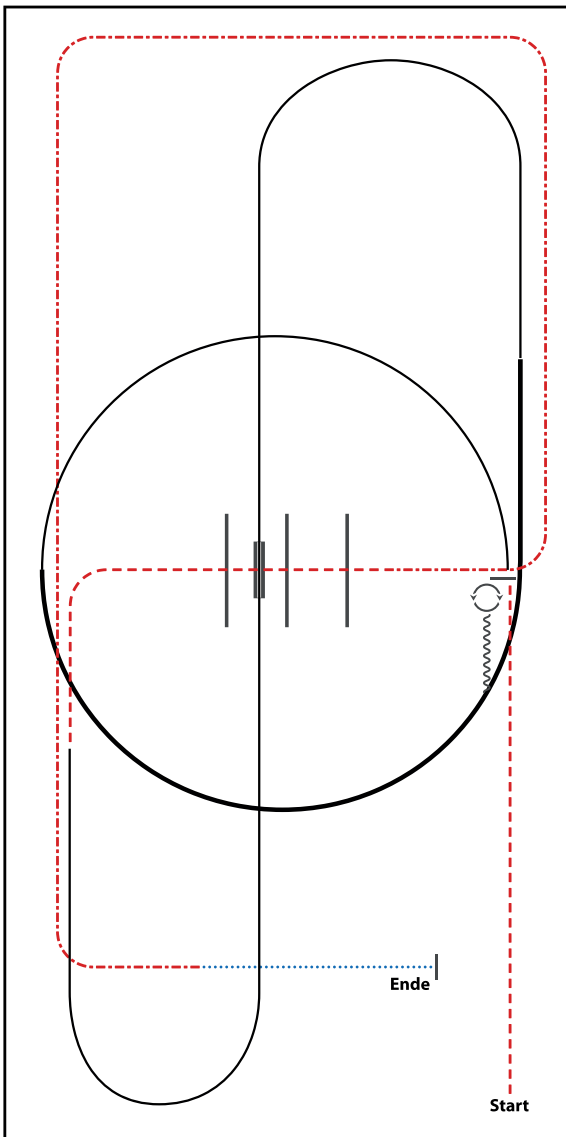

- 1) TROT
- 2) STOP, 180° TURNS EACH DIRECTION
- 3) BACK UP
- 4) LOPE (LL)
- 5) EXTENDED LOPE (LL), LOPE (LL)
- 6) CHANGE LEADS (SIMPLE OR FLYING)
- 7) LOPE (RL)
- 8) TROT, TROT OVER
- 9) EXTENDED TROT
- 10) WALK, STOP

WALK (SCHRITT)
EXTENDED WALK
JOG/TROT (TRAB)
EXTENDED TROT
LOPE (GALOPP)	—————
EXTENDED LOPE	—————
BACK UP (RÜCKWÄRTS)	~~~~~
LEAD CHANGE (GALOPPWECHSEL)	=====
TURN (DREHUNG)	↻
ERSTE	—————
WESTENREITER	—————
UNION	—————
WESTDEUTSCHER REITVERBAND	—————



Unsere Hauptsponsoren



Danke für die Unterstützung!

EWU-BAYERN.EV
www.ewu-bayern.de

Teilnehmer: C-Turnier I/24 Niedertaufkirchen OBB-Meisterschaft

Start Nr.	Reiter	LK	LV	Pferd	Rasse
1	Katharina Vogel LK 1-3 RN ,LK 1/2 RR ,Z LK 1/2 RN ,Z LK 1/2 RR	LK 2A	BAY	RH Stormkitty Solano	QH
2	Katharina Vogel SO GH RR ,SO GH WHS ,SO GH WPL	LK 2A	BAY	SR Sparkling Flash	QH
3	Lisa Prager LK 1/2 RR ,LK 1/2 WRR ,Z LK 1/2 RR ,Z LK 1/2 TH ,Z LK 1/2 WRR	LK 2A	BAY	SH Texchex Leo	QH
4	Kathrin Gastorfer LK 1-3 WPL ,LK 1/2 WHS ,Z LK 1/2 WPL	LK 1A	BAY	Dynadark Hot Lover	QH
5	Isabel Meyer LK 4/5 A TH ,LK 4/5 A WHS ,LK 4/5 A WPL ,LK 4A RR ,LK 4A WRR ,SO GH RR ,SO GH TH ,SO GH WHS ,SO GH WPL	LK 4A	BAY	Seven Kisses For Me	PH
6	Rebecca Huber LK 1-3 WPL ,LK 3 TH ,LK 3 WHS ,LK 3 WRR ,LK 3A RR ,SO GH RR ,SO GH WPL	LK 3A	BAY	Smokyguns Devilrose	QH/PH
7	Michaela Hohenauer LK 1-3 RN ,LK 1-3 WPL ,LK 3 TH ,LK 3 WRR ,LK 3A RR ,SO GH RR ,SO GH WPL	LK 3A	BAY	Black Prince Lesharo	APP
8	Jasmin Dillitz LK 4/5 A TH ,LK 4/5 A WHS ,LK 4/5 A WPL ,LK 4A RR ,LK 4A WRR ,SO GH WHS	LK 4A	BAY	Tari Whizin Jack	QH
9	Emelie Zeulner LK 4 RN ,LK 4B RR ,LK 4B WRR	LK 4B	BAY	Spotted Rocketman	APP
10	Christina Kirmeier LK 1-3 RN ,LK 1-3 WPL ,LK 3 TH ,LK 3 WHS ,LK 3 WRR ,LK 3B RR	LK 3B	BAY	Sternbergs Make Me Happy	CON
11	Bianca Wandinger LK 4 RN ,LK 4/5 A TH ,LK 4/5 A WPL ,LK 4A RR ,LK 4A WRR ,SO GH RR ,SO GH TH ,SO GH WPL	LK 4A	BAY	My Colonel Gunlight	QH
12	Johanna Fuchs LK 3 TH ,LK 3 WHS ,LK 3A RR ,SO GH RR ,SO GH TH	LK 3A	BAY	Spat Dry Lena	QH
13	Sabrina Huber LK 4/5 A TH ,LK 4/5 A WHS ,LK 4/5 A WPL ,LK 4/5 SSH ,LK 4A RR ,LK 4A WRR	LK 4A	BAY	GK Puro Pine	QH
14	Theresa Ludwig LK 1-3 WPL ,LK 3 WHS ,LK 3 WRR ,LK 3B RR	LK 3B	BAY	A Redbull	QH
15	Alexandra Ludwig LK 4/5 A TH ,LK 4/5 A WHS ,LK 4A RR	LK 4A	BAY	Whoomer	QH
16	Theresa Ludwig LK 3 TH ,LK 3B RR	LK 3B	BAY	Whoomer	QH
17	Claudia Huber LK 1-3 WPL ,LK 1/2 RR ,LK 1/2 SSH ,LK 1/2 TH ,LK 1/2 WHS ,Z LK 1/2 RR ,Z LK 1/2 TH ,Z LK 1/2 WHS ,Z LK 1/2 WPL	LK 1A	BAY	Hesa Indian Cat	PH
18	Manuela Geier LK 1-3 RN ,LK 1-3 WPL ,LK 1/2 RR ,LK 1/2 TH ,LK 1/2 WRR ,Z LK 1/2 RN ,Z LK 1/2 RR ,Z LK 1/2 WPL ,Z LK 1/2 WRR	LK 2A	BAY	WB Smokin Serenade	QH
19	Carina Schubert LK 3 TH ,LK 3 WHS ,LK 3 WRR ,LK 3A RR ,SO GH RR ,SO GH TH ,SO GH WHS	LK 3A	BAY	AbileneBlueSmartSujo	PH
20	Johanna Ebenbeck LK 1-3 WPL ,LK 3 SSH ,LK 3 TH ,LK 3 WHS ,SO GH TH ,SO GH WHS	LK 3A	BAY	Only Codys Carpediem	QH
21	Marion Seehuber LK 4/5 A TH	LK 4A	BAY	Mirabelle 64	WFL
22	Alexandra Pilger LK 4/5 A TH ,LK 4/5 A WHS ,LK 4/5 A WPL ,LK 4A RR	LK 4A	BAY	Granada	AN

Teilnehmer: C-Turnier I/24 Niedertaufkirchen OBB-Meisterschaft

23 Iris Höß LK 1-3 WPL ,LK 3 SSH ,LK 3 TH ,LK 3 WHS ,LK 3 WRR	LK 3A	BAY	FM Ultimative Maxine	PH
24 Helen Schairer LK 1/2 RR ,LK 1/2 TH ,LK 1/2 WHS ,LK 1/2 WRR ,Z LK 1/2 WHS	LK 2A	BAWÜ	Please Jac My Train	QH
25 Magdalena Seehuber SO FZ TH	LK 5B		Mirabelle 64	WFL
26 Christina-Marie Egerer LK 1-3 WPL ,SO GH WHS ,SO GH WPL	LK 3A	BAY	Flame Of Wimpy	QH
27 Carola Gschwendtner-Doll SO GH RR ,SO GH TH ,SO GH WHS ,SO GH WPL	LK 3A	BAY	Tobemissmoneypenny	PH
28 Emma Kainzlsperger WT RR ,WT TH ,WT WHS ,WT WPL	LK 5B		Tippi	PH
29 Nadine Hartmann LK 1-3 RN ,LK 1/2 RR ,LK 1/2 WRR ,Z LK 1/2 RN ,Z LK 1/2 RR ,Z LK 1/2 TH ,Z LK 1/2 WHS ,Z LK 1/2 WRR	LK 1A	BAY	TALISMANIC ROOSTER	QH
30 Andrea Kroppus LK 1/2 RR ,LK 1/2 WRR ,SO GH RR ,Z LK 1/2 RR ,Z LK 1/2 WRR	LK 2A	SACHS	Big Guns Lady Rietta	PH
31 Sabrina Kastner LK 1-3 RN ,LK 1-3 WPL ,LK 3 WRR ,LK 3A RR	LK 3A	BAY	Whiztopep	QH
32 Ulrike Stowasser LK 4/5 A TH ,LK 4/5 A WHS ,LK 4A RR	LK 4A	BAY	Sir Henry Buck	QH
33 Catharina Falch LK 1/2 TH ,LK 1/2 WHS ,Z LK 1/2 TH ,Z LK 1/2 WHS ,Z LK 1/2 WPL	LK 1A	BAY	Docs Jane To Cash	QH
34 Lena Koschorreck LK 1-3 WPL ,LK 3 WHS ,LK 3 WRR ,LK 3A RR ,SO GH RR ,SO GH TH ,SO GH WHS ,SO GH WPL	LK 3A	BAY	Don Mega Okietoo	QH
35 Leonie Christoph WT WPL	LK 5B		Flame Of Wimpy	QH
36 Christina Danninger LK 1-3 RN ,Z LK 1/2 RN ,Z LK 1/2 RR	LK 1A	BAY	Smart Little Lilith	APP
37 Roswitha Huber LK 4/5 A TH ,LK 4/5 A WHS ,LK 4/5 A WPL ,LK 4A RR ,LK 4A WRR	LK 4A	BAY	WH Sam Hockins	APP
38 Swenja Kopplin LK 3 TH ,LK 3 WHS ,LK 3 WRR ,LK 3A RR ,SO GH RR ,SO GH TH ,SO GH WHS	LK 3A	BAY	Brain	Hal
39 Regina Vilsmeier LK 1/2 RR ,LK 1/2 TH ,LK 1/2 WHS ,SO GH RR ,SO GH TH ,SO GH WHS ,Z LK 1/2 RR ,Z LK 1/2 TH ,Z LK 1/2 WHS	LK 2A	BAY	Reina Haida	QH
40 Josephine Krapf LK 4/5 B TH ,LK 5B WHS	LK 5B		Dun it Bella Queen	QH
41 Vanessa Offermann LK 3 TH	LK 3A	BAY	Spat King Delmaso	QH
42 Luisa Kleist WT TH	LK 5B		Spat King Delmaso	QH
43 Josephina Offermann SO FZ TH	LK 5B		Spat King Delmaso	QH
44 Alina Michler LK 4 RN ,LK 4/5 B WPL ,LK 4B RR ,LK 4B WHS ,LK 4B WRR	LK 4B	BAY	VQH Deltas Arrow	PH
45 Maria Höß LK 1/2 SSH ,Z LK 1/2 WPL	LK 2A	BAY	FM Ultimative Maxine	PH
46 Leonie Christoph WT WHS	LK 5B		Baccara	Hal

Teilnehmer: C-Turnier I/24 Niedertaufkirchen OBB-Meisterschaft

47 Paulina Rappl LK 4/5 B WPL ,LK 5B WHS	LK 5B		Flame Of Wimpy	QH
48 Verena Frommlet LK 4/5 A TH ,LK 4/5 A WHS ,LK 4/5 A WPL ,LK 4/5 SSH	LK 4A	BAY	SQ Boogies Investment	PH
49 Tamara Petzendorfer LK 4 RN ,LK 4/5 B TH ,LK 4/5 B WPL ,LK 4B WHS ,LK 4B WRR ,SO GH RR	LK 4B	BAY	Aughnasilla Bobby	CON
50 Romy Stannecker LK 3 WRR ,LK 3B RR	LK 3B	BAY	What's Up	EHAL
51 Yvonne Ascherl LK 4/5 A TH ,LK 4/5 A WPL	LK 5A		Keepme Loveme Kruzme	QH
52 Sophia Alina Hagendorn Z LK 1/2 RN ,Z LK 1/2 RR ,Z LK 1/2 TH ,Z LK 1/2 WRR	LK 1B	BAY	KH Miss Tinselgun	QH
53 Lina Pfaffinger LK 1/2 WRR ,Z LK 1/2 RR ,Z LK 1/2 WRR	LK 2A	BAY	JS Poco Blue Jac Dun	APP
54 Katharina Ascherl LK 4/5 B TH ,LK 4/5 B WPL ,LK 4/5 SSH ,LK 5B WHS	LK 5B		Keepme Loveme Kruzme	QH
55 Sophia Ascherl LK 4/5 B TH ,LK 4/5 SSH ,LK 4B RR ,LK 4B WHS	LK 4B	BAY	Brioni Boon	QH
56 Simone Fiedler LK 1-3 RN ,Z LK 1/2 RN	LK 2A	BAY	Ruf Kid Dont Spook	QH
57 Luna Schnitzler LK 1/2 RR ,LK 1/2 TH ,LK 1/2 WHS ,LK 1/2 WRR ,Z LK 1/2 RR ,Z LK 1/2 TH ,Z LK 1/2 WHS ,Z LK 1/2 WRR	LK 2B	BAY	Smart as you	QH
58 Angelika Sandbichler LK 1/2 WRR ,SO GH RR ,SO GH TH ,Z LK 1/2 RR	LK 1A	BAY	BH We Win Situation	QH
59 Angelika Sandbichler Z LK 1/2 RR ,Z LK 1/2 WRR	LK 1A	BAY	What's Up	EHAL
60 Julia Katscher-Vetter LK 4A RR	LK 4A	BAY	Perl	NO
61 Mona Schneeberger LK 4/5 A TH ,LK 4/5 A WHS ,LK 5 RR	LK 5A		Boon Badger Special	QH
62 Jana Simon LK 1-3 WPL ,LK 3 SSH ,LK 3 WHS	LK 3A	BAY	Elta Crome	QH
63 Verena Kornes LK 3 TH ,LK 3 WRR ,LK 3A RR	LK 3A	BAY	TNT Peppys Best	PH
64 Nicole König LK 3 TH ,LK 3A RR	LK 3A	BAY	Monsun	FJ
65 Lena Linnerer LK 4/5 A TH ,LK 4A RR	LK 4A	BAY	Justice Pay Gold	QH
66 Sophia Strein LK 4/5 A TH ,LK 4A RR ,LK 4A WRR	LK 4A	BAY	Hollister Bobby	QH
67 Penelope Kallinteris LK 4/5 A TH ,LK 4/5 A WHS ,LK 4/5 A WPL ,LK 5 RR	LK 5A		Bojos Yutan Bonanza	QH
68 Carolin Stichaner LK 4/5 B TH	LK 5B		Spat King Delmaso	QH
69 Kathrin Sedlmeier LK 1-3 RN ,LK 1/2 RR ,LK 1/2 WRR ,Z LK 1/2 RN ,Z LK 1/2 RR	LK 2A	BAY	Mega Scotch Rocker	QH
70 Isabella Stein SO FZ TH	LK 5B		Tara	IT

Teilnehmer: C-Turnier I/24 Niedertaufkirchen OBB-Meisterschaft

71 Emma Strahl LK 4/5 B TH ,LK 5 RR	LK 5B	BAY	Candy (Pinkie Pie 2)	TI
72 Tanja Reitmaier LK 3 TH ,LK 3 WRR ,LK 3A RR ,SO GH RR	LK 3A	BAY	Tara	IT
73 Simone Strahl LK 1/2 RR ,SO GH RR ,Z LK 1/2 RR ,Z LK 1/2 TH	LK 1A	BAY	My Hollywood Pearl	QH
74 Isabel Löschner LK 1/2 SSH ,LK 1/2 TH ,Z LK 1/2 TH	LK 1A	BAY	CS Elites Just Fun	QH
75 Sara Witalinski WT RR ,WT TH ,WT WHS	LK 5B		Blue Power	QH
76 Linda Nitz WT RR ,WT TH ,WT WHS ,WT WPL	LK 5B		UT Jinges Cherita	PH
77 Flora Nitz LK 4/5 B TH ,LK 5 RR ,LK 5B WHS	LK 5B		UT Jinges Cherita	PH
78 Selina Dexl LK 3 SSH ,LK 3 WHS	LK 3B	BAY	TNT Peppys Best	PH
79 Sophia Schwarz LK 1/2 SSH ,Z LK 1/2 WPL ,Z LK 1/2 WRR	LK 1B	BAY	Designed Only	QH
80 Felicia Gschöderer LK 4/5 B TH ,LK 4B RR ,LK 4B WRR	LK 4B	BAY	Lillys Big Time	QH
81 Daniela Arnold LK 1/2 TH	LK 2A	BAY	Lillys Big Time	QH
82 Christian Fellner LK 1/2 RR	LK 1A	BAY	Roosters Memory	QH
83 Christian Fellner LK 1/2 RR	LK 1A	BAY	Queen Elisabeth	QH
84 Angelika Sandbichler LK 1/2 RR ,Z LK 1/2 TH	LK 1A	BAY	Justice Pay Gold	QH
85 Andrea Erber LK 4 RN ,LK 4/5 B TH ,LK 4B RR ,LK 4B WHS ,LK 4B WRR	LK 4B	BAY	Pep Smart Olena	QH
86 Miriam Farnhammer LK 4B RR ,LK 4B WRR	LK 4B	BAY	TJ Smart Pale Face	QH
87 Lena Buttenberg LK 4B RR	LK 4B	BAY	Hollister Bobby	QH
88 Franzisca Niedermayr SO GH WPL	LK 1A	BAY	Blue Power	QH
89 Samuel Fuchs SO FZ TH	LK 5B	BAY	Spat Dry Lena	QH
90 Josef Fuchs LK 1/2 RR ,LK 1/2 TH ,LK 1/2 WRR ,Z LK 1/2 RR ,Z LK 1/2 TH ,Z LK 1/2 WRR	LK 2A	BAY	Cash Commander	QH
91 Emma Häusler SO FZ TH	LK 5B	BAY	Sweet Lil Flicka	QH
92 Stefanie Hasenpusch LK 4A WRR	LK 4A	BAY	Just My Style	QHM
93 Stefan Mayr LK 4/5 A TH ,LK 4/5 A WPL ,LK 4A RR	LK 4A	BAY	Aragon	KA
94 Lavinia Messerschmidt WT RR ,WT TH ,WT WHS ,WT WPL	LK 5B		Peptos Lil Macy	QH

Teilnehmer: C-Turnier I/24 Niedertaufkirchen OBB-Meisterschaft

95 Tanja Graf-Holten Z LK 1/2 RR ,Z LK 1/2 TH ,Z LK 1/2 WHS ,Z LK 1/2 WPL ,Z LK 1/2 WRR	LK 1A	BAY	HQ Onlys Commander	QH
96 Sonja Fink WT RR	LK 5A		WBC BELLA LITTLE LANA	PH
97 Veronika Seifert LK 3 TH ,LK 3 WRR ,LK 3A RR	LK 3A	BAY	Invitation Plaudit	QH
98 Liana Norén LK 3 TH ,LK 3 WRR ,LK 3B RR	LK 3B	BAY	Attila Q	Hal
99 Bianca Miller LK 3 SSH	LK 3A	BAY	Anytimes Bigsensation	PH



Unsere Produkte lassen Ihren Fuhrpark strahlen.



igepa-chemie GmbH
Mitterfeldstraße 7a | 93077 Bad Abbach
Tel. +49 (0)9405 / 9525-0 | info@clean-truck.de



www.clean-truck.de



FOLGE UNS



Hier geht's zum
CleanTruck-Shop



alex mundorff
western riding & country lifestyle

Speiseplan

EWU-C-Turnier

Oberbayerische Meisterschaft 2024



Schnitzel mit Kartoffelsalat o. Pommes	9,50€
Currywurst mit Pommes	7,50€
Leberkäse mit Kartoffelsalat	8,00€
Leberkässemmel	3,00€
Schnitzelsemmel	4,00€
Pommes	3,00€
Nudelsalat mit Brot	6,50€
Wurstsalat mit Brot	6,50€
Veggi Burger	5,00€
Freitag: Nudelsalat/Wurstsalat	9,00€
Samstag: Grillabend	11,00€

Handmade Saddles & Tack



Inhaber: Josef Fuchs
Werkstattleiter & Sattelbauer:
Manfred Aimer

Sherwood Ranch Saddlery

D-84494 Niedertaufkirchen
Hinteralbing 1

Mobil: +49 (0) 172 / 8 13 97 39
Telefon: +49 (0) 86 35 / 69 38 59

eMail: info@sherwoodranch.de

DIREKT AUF DER SHERWOODRANCH IN NIEDERTAUFKIRCHEN