

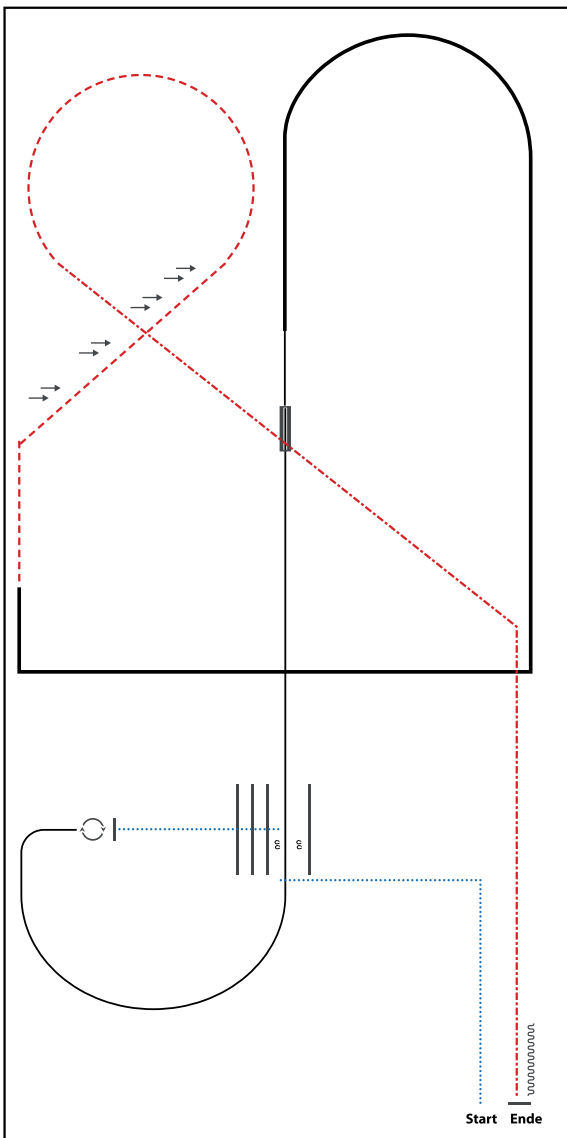

# Ranch Riding

## Pattern 1 - 35



- 1) WALK CORNER
- 2) SIDEPASS RIGHT, WALK OVER
- 3) STOP, 360° TURNS (EACH DIRECTION)
- 4) LOPE LL
- 5) CHANGE LEADS (SIMPLE OR FLYING), LOPE RL
- 6) EXTENDED LOPE RL
- 7) EXTENDED LOPE CORNERS
- 8) TROT, TROT TWO TRACK
- 9) TROT
- 10) EXTENDED TROT
- 11) STOP, BACK UP

WALK (SCHRITT)	
EXTENDED WALK	
JOG/TROT (TRAB)	
EXTENDED TROT	
LOPE (GALOPP)	
EXTENDED LOPE	
BACK UP (RÜCKWÄRTS)	
LEAD CHANGE (GALOPPWECHSEL)	
TURN (DREHUNG)	
ERSTE	
WESTENREITER	
UNION	
PROGRESSIFER/STRECKEN WECHSELN	

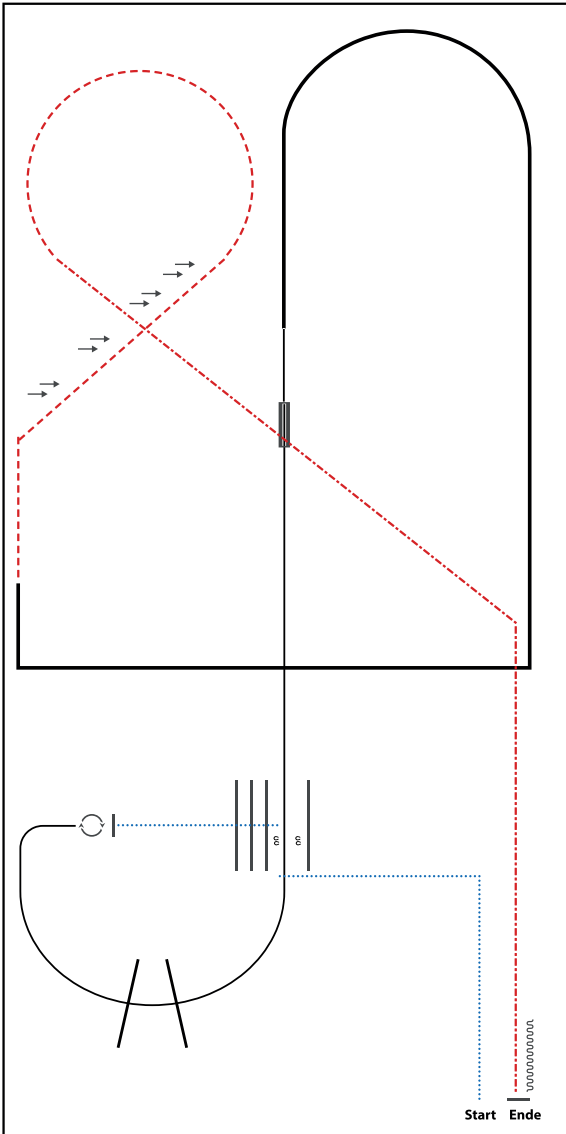

- 1) WALK CORNER
- 2) SIDEPASS RIGHT, WALK OVER
- 3) STOP, 360° TURNS (EACH DIRECTION)
- 4) LOPE LL, LOPE OVER
- 5) CHANGE LEADS (SIMPLE OR FLYING), LOPE RL
- 6) EXTENDED LOPE RL
- 7) EXTENDED LOPE CORNERS
- 8) TROT, TROT TWO TRACK
- 9) TROT
- 10) EXTENDED TROT
- 11) STOP, BACK UP

WALK (SCHRITT)	
EXTENDED WALK	
JOG/TROT (TRAB)	
EXTENDED TROT	
LOPE (GALOPP)	
EXTENDED LOPE	
BACK UP (RÜCKWÄRTS)	
LEAD CHANGE (GALOPPWECHSEL)	
TURN (DREHUNG)	
ERSTE	
WESTENREITER	
UNION	
PROGRESSIFER/STRECKT GALOPP	







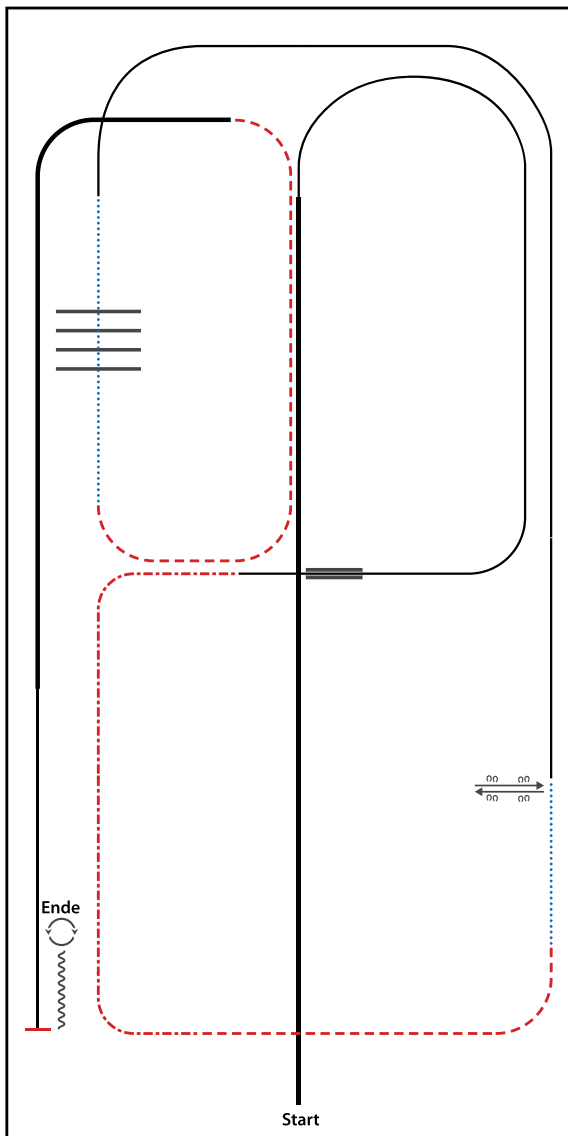

- 1) EXTENDED LOPE (RL)
- 2) LOPE (RL)
- 3) CHANGE LEADS (SIMPLE OR FLYING), LOPE (LL)
- 4) EXTENDED TROT
- 5) TROT
- 6) WALK
- 7) SIDEPASS LEFT, SIDEPASS RIGHT HALF WAY
- 8) LOPE (LL)
- 9) WALK OVER
- 10) TROT
- 11) EXTENDED LOPE (LL), LOPE (LL)
- 12) STOP, BACK UP
- 13) 360° TURNS (EACH DIRECTION)

WALK (SCHRITT)	
EXTENDED WALK	
JOG/TROT (TRAB)	
EXTENDED TROT	
LOPE (GALOPP)	
EXTENDED LOPE	
BACK UP (RÜCKWÄRTS)	
LEAD CHANGE (GALOPPWECHSEL)	
TURN (DREHUNG)	
	ERSTE
	WESTBREITER
	UNION
	WELDFORPENSCHULEN





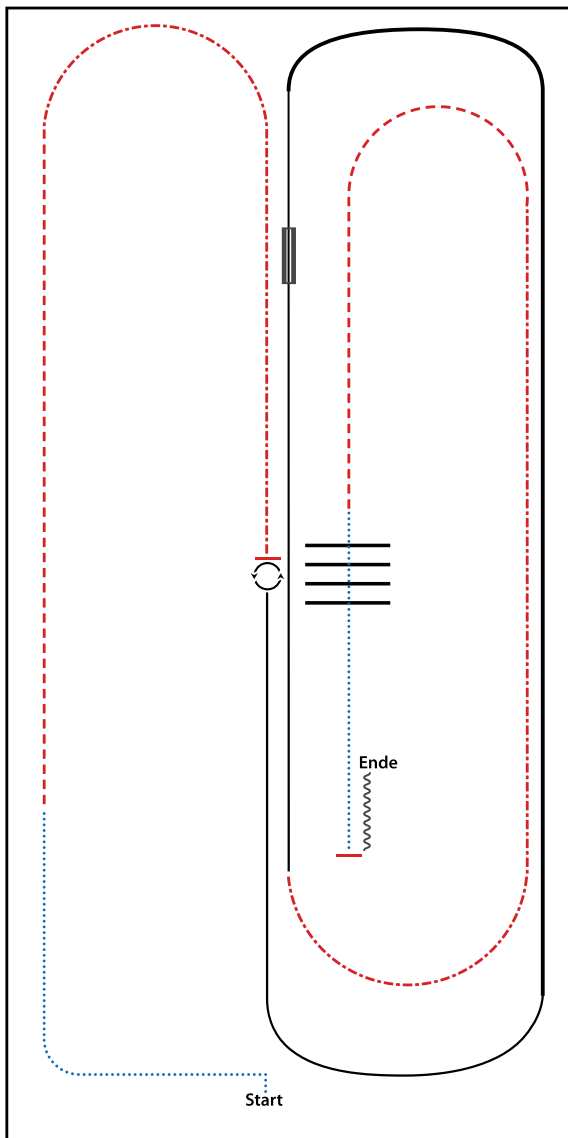

- 1) WALK
- 2) TROT
- 3) EXTENDED TROT
- 4) STOP, 360° TRUNS (EACH DIRECTION)
- 5) LOPE (LL)
- 6) EXTENDED LOPE (LL)
- 7) LOPE (LL), CHANGE LEADS (SIMPLE OR FLYING)
- 8) LOPE (RL)
- 9) EXTENDED TROT
- 10) TROT
- 11) WALK OVER
- 12) STOP, BACK UP

WALK (SCHRITT)	
EXTENDED WALK	
JOG/TROT (TRAB)	
EXTENDED TROT	
LOPE (GALOPP)	
EXTENDED LOPE	
BACK UP (RÜCKWÄRTS)	
LEAD CHANGE (GALOPPWECHSEL)	
TURN (DREHUNG)	
	ERSTE
	WESTENREITER
	UNION
	WELDPFERDEBUND WESTERWALD





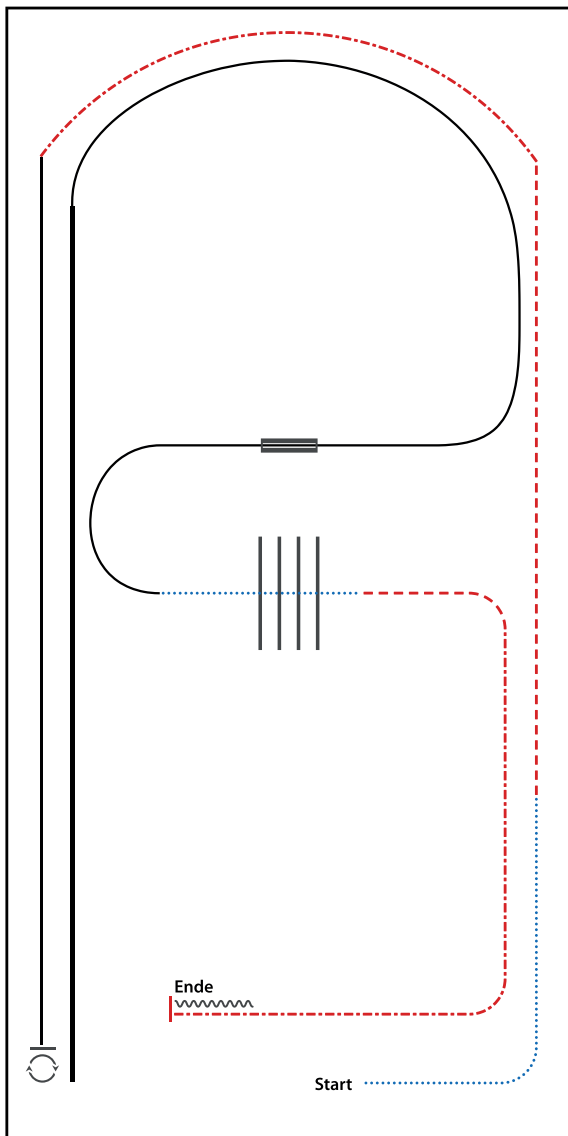

- 1) WALK
- 2) TROT
- 3) EXTENDET TROT
- 4) LOPE (LL)
- 5) STOP, 540° TURN RIGHT
- 6) EXTENDED LOPE (RL)
- 7) LOPE (RL)
- 8) CHANGE LEADS (SIMPLE OR FLYING), LOPE (LL)
- 9) WALK, WALK OVER
- 10) TROT
- 11) EXTENDED TROT
- 12) STOP, BACK UP

WALK (SCHRITT)	
EXTENDED WALK	
JOG/TROT (TRAB)	
EXTENDED TROT	
LOPE (GALOPP)	
EXTENDED LOPE	
BACK UP (RÜCKWÄRTS)	
LEAD CHANGE (GALOPPWECHSEL)	
TURN (DREHUNG)	
ERSTE	
WESTENREITER	
UNION	
WESTENREITER UND WESTENREITER	





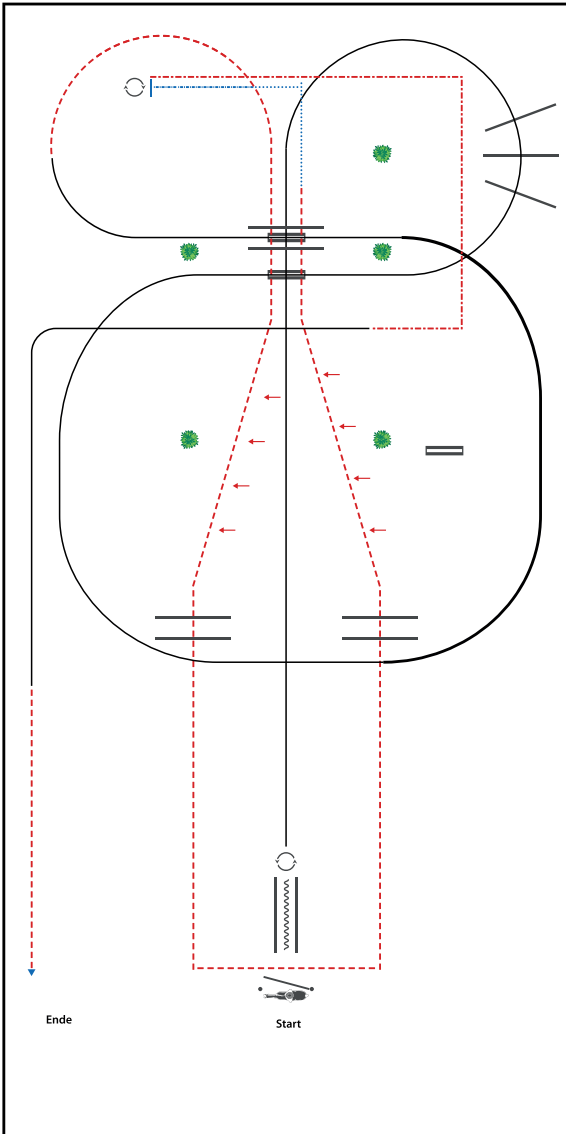

- 1) GATE
- 2) BACK UP
- 3) 540° TURN LEFT
- 4) LOPE (RL), LOPE OVER
- 5) CHANGE LEADS (SIMPLE OR FLYING), LOPE (LL),
- 6) EXTENDED LOPE (LL), CHANGS LEADS (SIMPLE OR FLYING), LOPE (RL)
- 7) CHANGE LEADS, LOPE (LL)
- 8) TROT, TROT OVER, TWO TRACK RIGHT AND LEFT
- 9) WALK, EXTENDED WALK
- 10) 540° TURN RIGHT
- 11) EXTENDED TROT CORNERS
- 12) LOPE (LL) CORNER, TROT OUT

WALK (SCHRITT)	
EXTENDED WALK	
JOG/TROT (TRAB)	
EXTENDED TROT	
LOPE (GALOPP)	
EXTENDED LOPE	
BACK UP (RÜCKWÄRTS)	
LEAD CHANGE (GALOPPWECHSEL)	
TURN (DREHUNG)	
ERSTE	
WESTENREITER	
UNION	
WESTENREITER WESTENREITER	

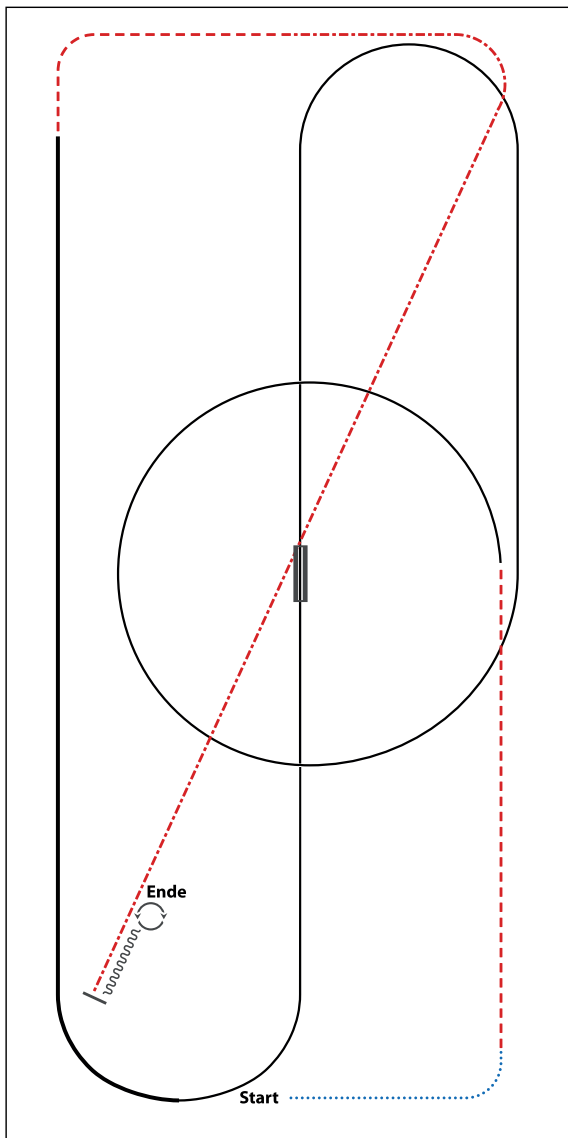

- 1) WALK
- 2) TROT
- 3) LOPE (LL) CIRCLE
- 4) CHANGE LEADS (SIMPLE OR FLYING)
- 5) LOPE (RL)
- 6) EXTENDED LOPE (RL)
- 7) TROT
- 8) EXTENDED TROT
- 9) STOP, BACK UP
- 10) 360° TURNS (EACH DIRECTION)

WALK (SCHRITT)	
EXTENDED WALK	
JOG/TROT (TRAB)	
EXTENDED TROT	
LOPE (GALOPP)	
EXTENDED LOPE	
BACK UP (RÜCKWÄRTS)	
LEAD CHANGE (GALOPPWECHSEL)	
TURN (DREHUNG)	
	ERSTE
	WESTENREITER
	UNION
	WIRTSCHAFTSUNIVERSITÄT SIEGEN





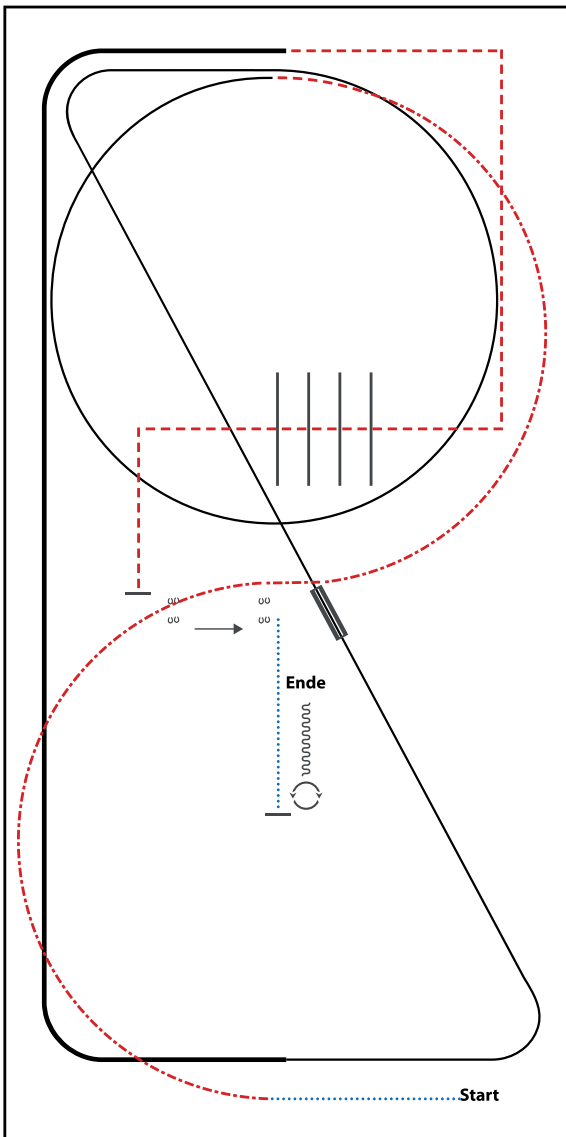

- 1) WALK
- 2) EXTENDED TROT, TROT
- 3) LOPE (LL) CIRCLE, LOPE (LL)
- 4) CHANGE LEADS (SIMPLE OR FLYING)
- 5) LOPE (RL)
- 6) EXTENDED LOPE (RL)
- 7) TROT CORNERS
- 8) TROT OVER, TROT
- 9) STOP, SIDEPASS LEFT
- 10) WALK, STOP
- 11) 360° TURN (LEFT OR RIGHT), BACK UP

WALK (SCHRITT)	.....
EXTENDED WALK	.....
JOG/TROT (TRAB)	.....
EXTENDED TROT	.....
LOPE (GALOPP)	.....
EXTENDED LOPE	.....
BACK UP (RÜCKWÄRTS)	.....
LEAD CHANGE (GALOPPWECHSEL)	.....
TURN (DREHUNG)	.....
	ERSTE ..... WESTENREITER ..... UNION ..... WIRTSCHAFTSUNIVERSITÄT ..... .....

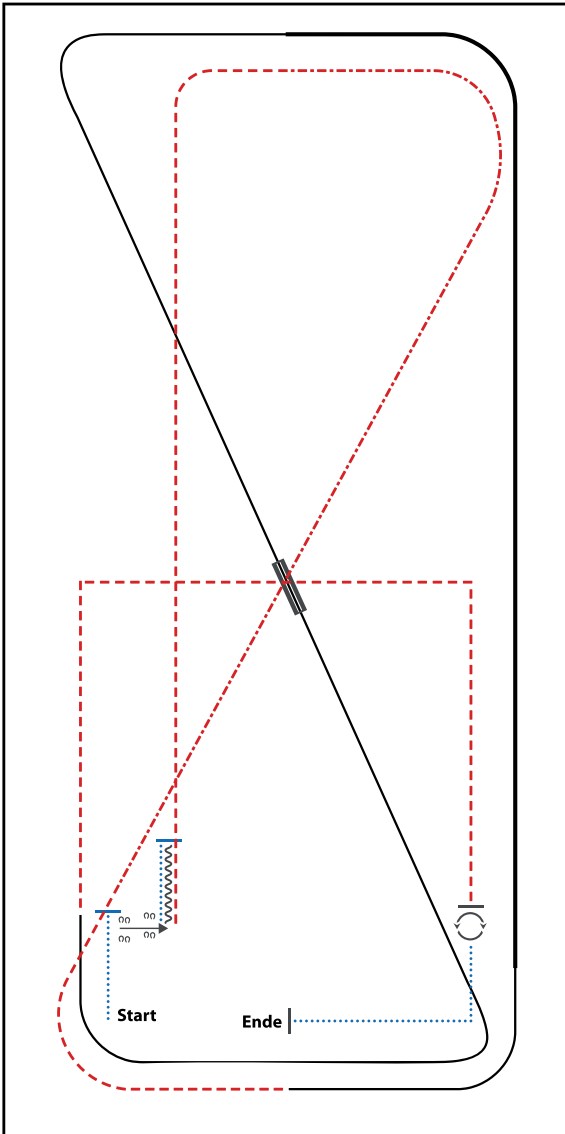

- 1) WALK, STOP
- 2) SIDEPASS RIGHT
- 3) WALK, STOP, BACK UP
- 4) TROT
- 5) EXTENDED TROT, TROT
- 6) LOPE (LL)
- 7) EXTENDED LOPE (LL), LOPE (LL)
- 8) CHANGE LEADS (SIMPLE OR FLYING)
- 9) LOPE (RL)
- 10) TROT CORNERS
- 11) STOP, 360° TURN (LEFT OR RIGHT)
- 12) WALK, STOP

WALK (SCHRITT)	
EXTENDED WALK	
JOG/TROT (TRAB)	
EXTENDED TROT	
LOPE (GALOPP)	
EXTENDED LOPE	
BACK UP (RÜCKWÄRTS)	
LEAD CHANGE (GALOPPWECHSEL)	
TURN (DREHUNG)	
	ERSTE
	WESTENREITER
	UNION
	WELDPFERDEBUND WESTERWALD

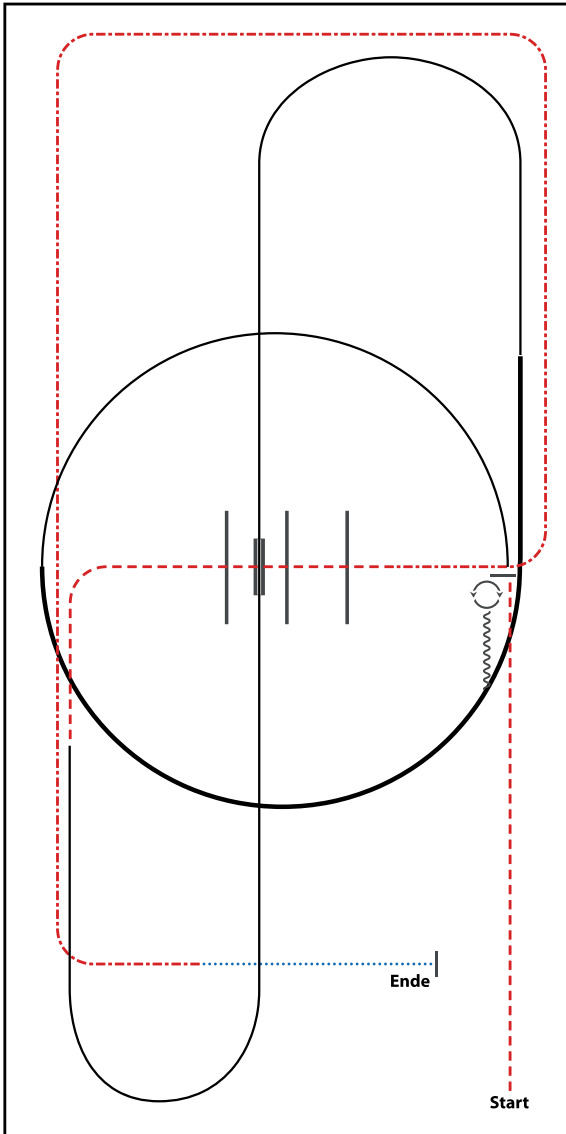

- 1) TROT
- 2) STOP, 180° TURNS EACH DIRECTION
- 3) BACK UP
- 4) LOPE (LL)
- 5) EXTENDED LOPE (LL), LOPE (LL)
- 6) CHANGE LEADS (SIMPLE OR FLYING)
- 7) LOPE (RL)
- 8) TROT, TROT OVER
- 9) EXTENDED TROT
- 10) WALK, STOP

WALK (SCHRITT)	
EXTENDED WALK	
JOG/TROT (TRAB)	
EXTENDED TROT	
LOPE (GALOPP)	
EXTENDED LOPE	
BACK UP (RÜCKWÄRTS)	
LEAD CHANGE (GALOPPWECHSEL)	
TURN (DREHUNG)	
	ERSTE
	WESTENREITER
	UNION
	WELDFÖRDERNDE VEREINIGUNG



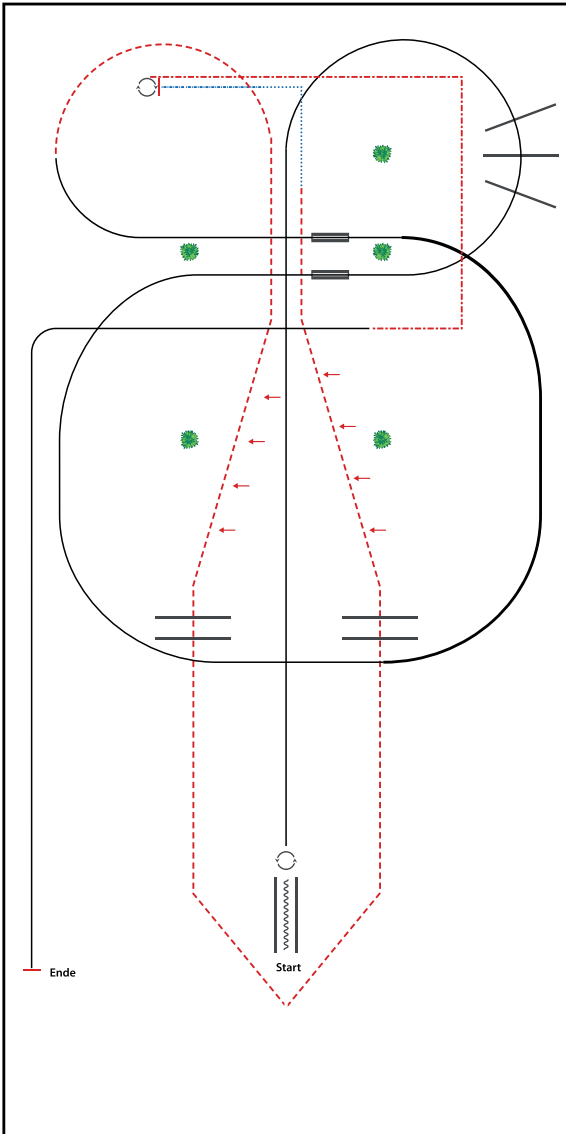

- 1) BACK UP
- 2) 450° TURN (LEFT OR RIGHT)
- 3) LOPE (RL), LOPE OVER
- 4) CHANGE LEADS, LOPE (LL)
- 5) EXTENDED LOPE (LL), COLLECTED LOPE (LL)
- 6) CHANGE LEADS, LOPE (RL)
- 7) TROT, TWO TRACK RIGHT, TROT OVER, CORNERS, TROT OVER, TWO TRACK LEFT
- 8) WALK, EXTENDED WALK
- 9) 450° TURN (LEFT OR RIGHT)
- 10) EXTENDED TROT CORNERS
- 11) LOPE (LL) CORNER, STOP

WALK (SCHRITT)	
EXTENDED WALK	
JOG/TROT (TRAB)	
EXTENDED TROT	
LOPE (GALOPP)	
EXTENDED LOPE	
BACK UP (RÜCKWÄRTS)	
LEAD CHANGE (GALOPPWECHSEL)	
TURN (DREHUNG)	
	ERSTE
	WESTENREITER
	UNION
	WELDFERREITERBUND

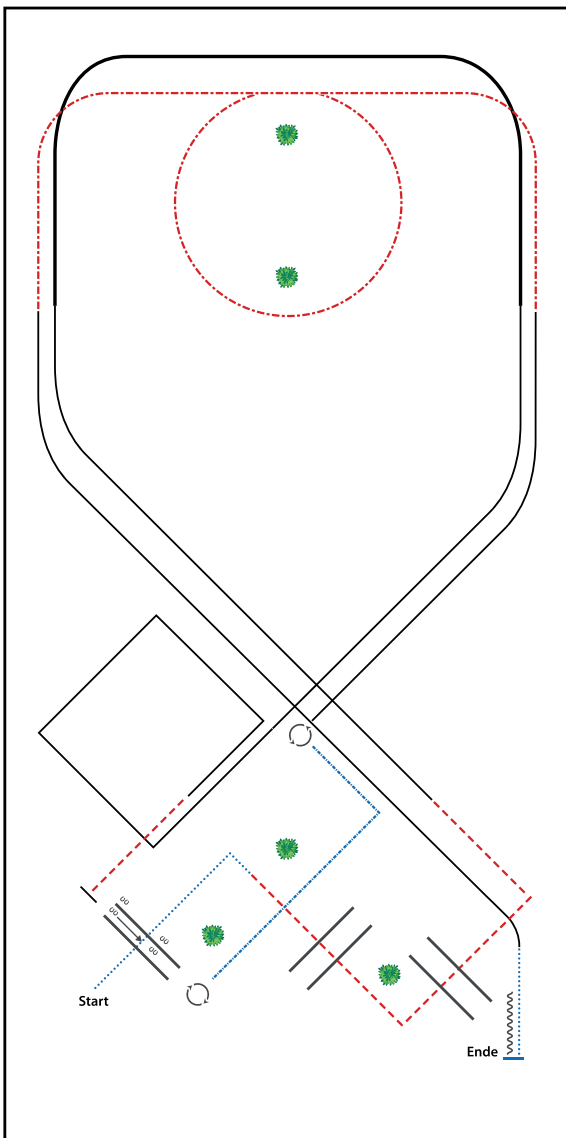

- 1) WALK OVER, WALK CORNER
- 2) TROT OVER AND CORNER
- 3) LOPE (RL)
- 4) EXTENDED LOPE (RL)
- 5) COLLECTED LOPE (RL), LOPE CORNERS
- 6) TROT, STOP
- 7) SIDEPASS LEFT
- 8) 45° TURN LEFT
- 9) EXTENDED WALK CORNER
- 10) STOP, 45° TURN RIGHT
- 11) LOPE (LL)
- 12) EXTENDED TROT
- 13) LOPE (LL), CHANGE LEADS, LOPE (RL)
- 14) WALK, STOP, BACK UP

WALK (SCHRITT)	
EXTENDED WALK	
JOG/TROT (TRAB)	
EXTENDED TROT	
LOPE (GALOPP)	
EXTENDED LOPE	
BACK UP (RÜCKWÄRTS)	
LEAD CHANGE (GALOPPWECHSEL)	
TURN (DREHUNG)	
	ERSTE
	WESTENREITER
	UNION
	WESTERUNION

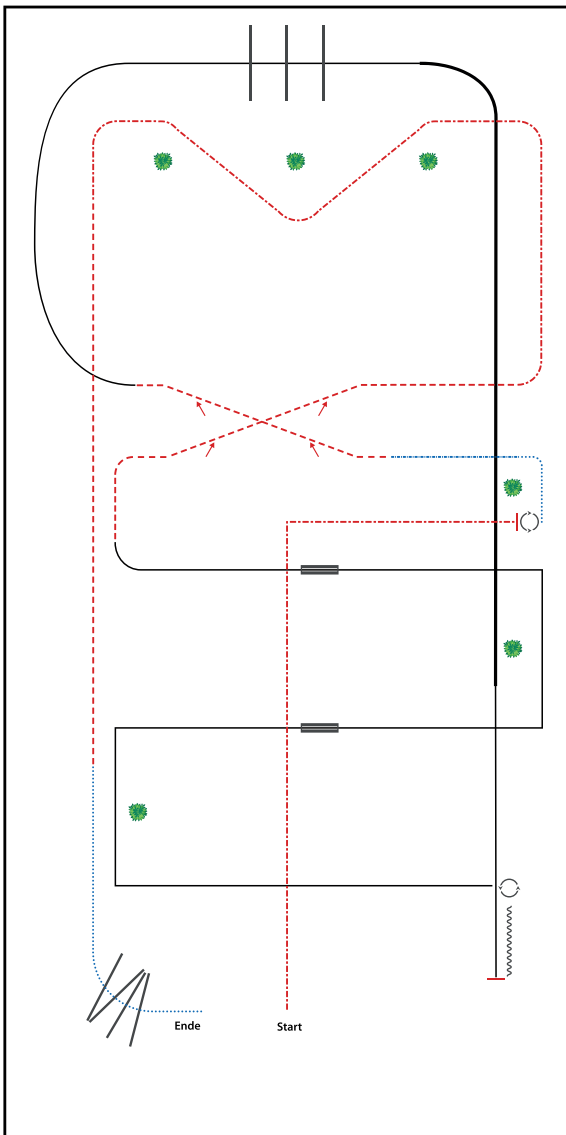

- 1) EXTENDED TROT CORNER
- 2) STOP, 2¼ TURN LEFT
- 3) WALK, EXTENDED WALK
- 4) TROT, TWO TRACK RIGHT
- 5) LOPE (RL), LOPE OVER
- 6) EXTENDED LOPE (RL), COLLECTED LOPE (RL)
- 7) STOP, BACK UP
- 8) 2¼ TURN RIGHT
- 9) LOPE (RL) CORNERS
- 10) CHANGE LEADS, LOPE (LL) CORNERS
- 11) CHANGE LEADS, LOPE (RL)
- 12) TROT, TWO TRACK LEFT
- 13) EXTENDED TROT, TROT
- 14) WALK, WALK OVER, WALK OUT

WALK (SCHRITT)	.....
EXTENDED WALK	.....
JOG/TROT (TRAB)	.....
EXTENDED TROT	.....
LOPE (GALOPP)	.....
EXTENDED LOPE	.....
BACK UP (RÜCKWÄRTS)	~~~~~
LEAD CHANGE (GALOPPWECHSEL)	=====
TURN (DREHUNG)	⤵
ERSTE	=====
WESTENREITER	=====
UNION	=====
WESTENREITER	=====



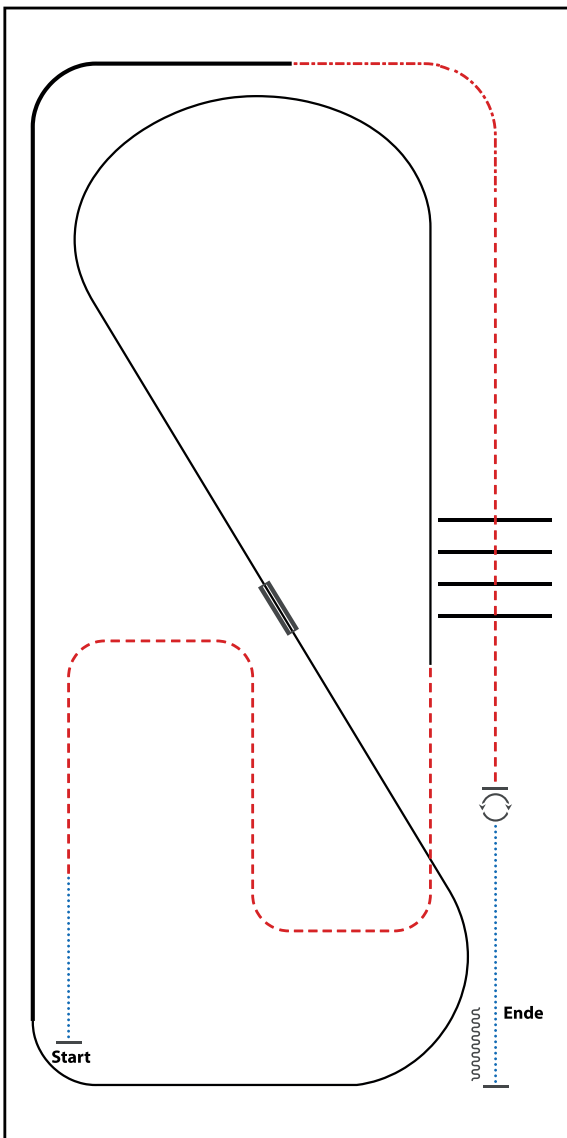

- 1) WALK
- 2) TROT
- 3) LOPE (LL)
- 4) CHANGE LEADS (SIMPLE OR FLYING)
- 5) LOPE (RL)
- 6) EXTENDED LOPE (RL)
- 7) EXTENDED TROT
- 8) TROT
- 9) TROT OVER
- 10) STOP, TURNS 360° (EACH DIRECTION)
- 11) WALK, STOP, BACK UP

WALK (SCHRITT)	
EXTENDED WALK	
JOG/TROT (TRAB)	
EXTENDED TROT	
LOPE (GALOPP)	
EXTENDED LOPE	
BACK UP (RÜCKWÄRTS)	
LEAD CHANGE (GALOPPWECHSEL)	
TURN (DREHUNG)	
	ERSTE
	WESTENREITER
	UNION
	WELDFORP/STRECKE/WECHSELREITER

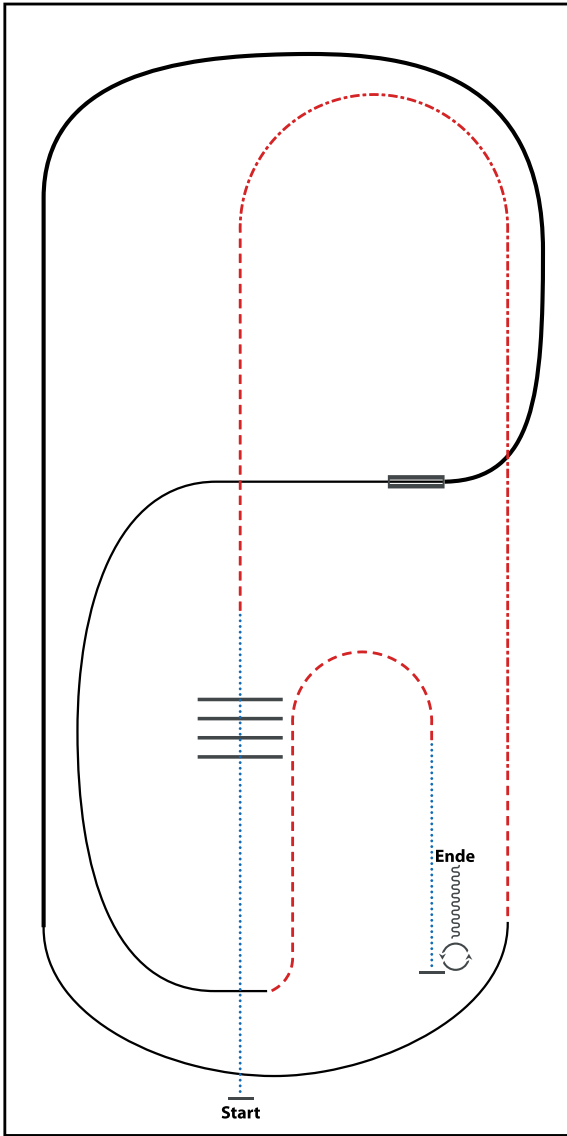

- 1) WALK OVER
- 2) TROT
- 3) EXTENDED TROT, TROT
- 4) LOPE (RL)
- 5) EXTENDED LOPE (RL)
- 6) CHANGE LEADS (SIMPLE OR FLYING)
- 7) LOPE (LL)
- 8) TROT
- 9) WALK
- 10) STOP, TURNS 360° (EACH DIRECTION)
- 11) BACK UP

WALK (SCHRITT)	
EXTENDED WALK	
JOG/TROT (TRAB)	
EXTENDED TROT	
LOPE (GALOPP)	
EXTENDED LOPE	
BACK UP (RÜCKWÄRTS)	
LEAD CHANGE (GALOPPWECHSEL)	
TURN (DREHUNG)	
ERSTE	
WESTENREITER	
UNION	
WESTENREITER	

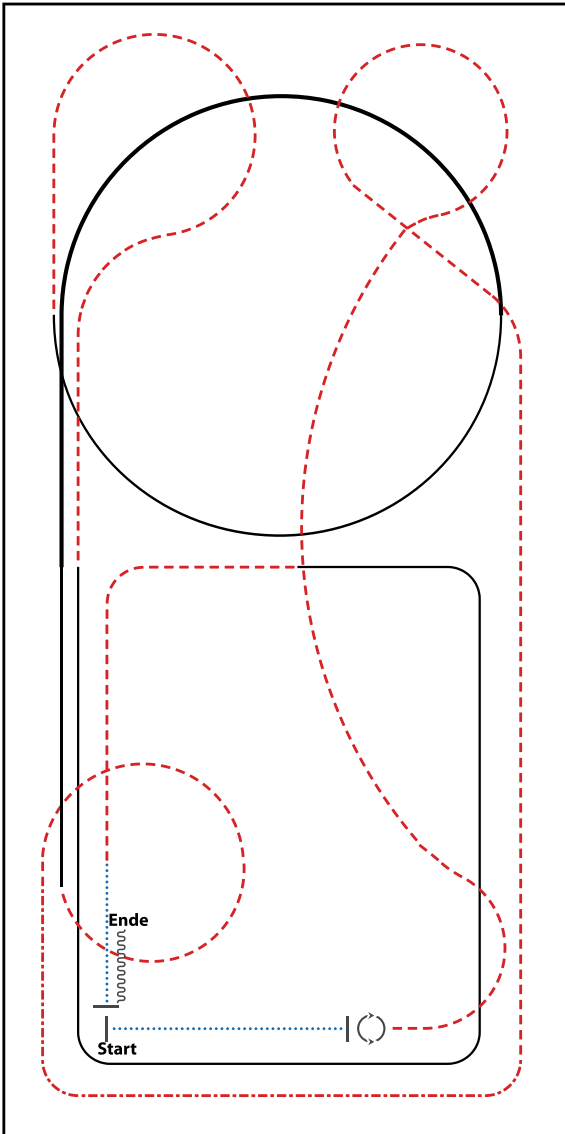

- 1) WALK
- 2) STOP, TURNS 360° (EACH DIRECTION)
- 3) TROT
- 4) EXTENDED TROT, TROT
- 5) LOPE (RL), EXTENDED LOPE (RL), LOPE (RL)
- 6) TROT
- 7) LOPE (LL)
- 8) TROT, WALK
- 9) STOP, BACK UP

WALK (SCHRITT)	
EXTENDED WALK	
JOG/TROT (TRAB)	
EXTENDED TROT	
LOPE (GALOPP)	
EXTENDED LOPE	
BACK UP (RÜCKWÄRTS)	
LEAD CHANGE (GALOPPWECHSEL)	
TURN (DREHUNG)	
	ERSTE
	WESTENREITER
	UNION
	WORLDSPORTREITER





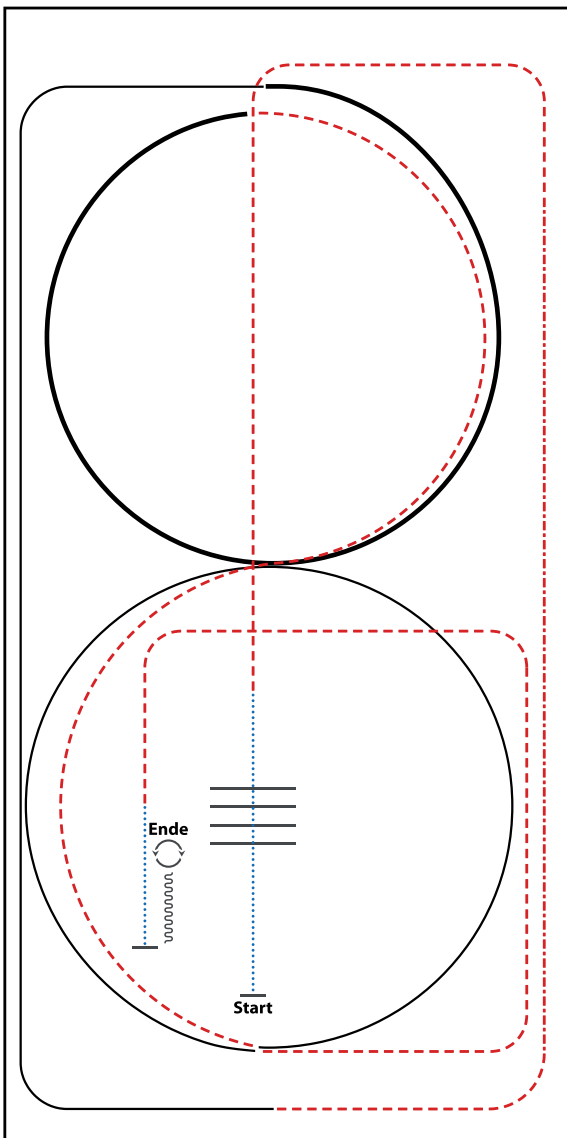

- 1) WALK, WALK OVER
- 2) TROT
- 3) EXTENDED TROT, TROT
- 4) LOPE (RL)
- 5) EXTENDED LOPE (RL)
- 6) TROT (2x ½ CIRCLE)
- 7) LOPE (LL)
- 8) TROT
- 9) WALK
- 10) STOP, BACK UP
- 11) TURN 180° RIGHT
- 12) TURN 180° LEFT

WALK (SCHRITT)	
EXTENDED WALK	
JOG/TROT (TRAB)	
EXTENDED TROT	
LOPE (GALOPP)	
EXTENDED LOPE	
BACK UP (RÜCKWÄRTS)	
LEAD CHANGE (GALOPPWECHSEL)	
TURN (DREHUNG)	
	ERSTE
	WESTENREITER
	UNION
	WELDPFERDEBUND WESTENREITER

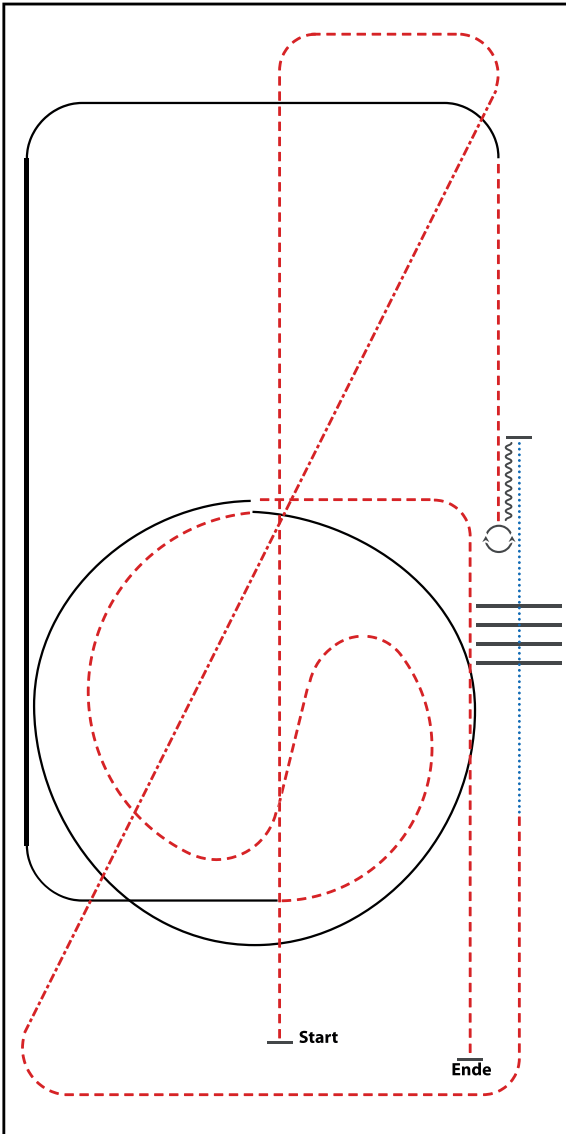

- 1) TROT
- 2) EXTENDED TROT, TROT
- 3) WALK OVER
- 4) WALK
- 5) STOP, BACK UP
- 6) TURN 180° RIGHT
- 7) TURN 180° LEFT
- 8) TROT
- 9) LOPE (LL)
- 10) EXTENDED LOPE (LL), LOPE (LL)
- 11) TROT
- 12) LOPE (RL)
- 13) TROT, STOP

WALK (SCHRITT)	
EXTENDED WALK	
JOG/TROT (TRAB)	
EXTENDED TROT	
LOPE (GALOPP)	
EXTENDED LOPE	
BACK UP (RÜCKWÄRTS)	
LEAD CHANGE (GALOPPWECHSEL)	
TURN (DREHUNG)	
	ERSTE
	WESTENREITER
	UNION
	WESTENREITER
	WESTENREITER







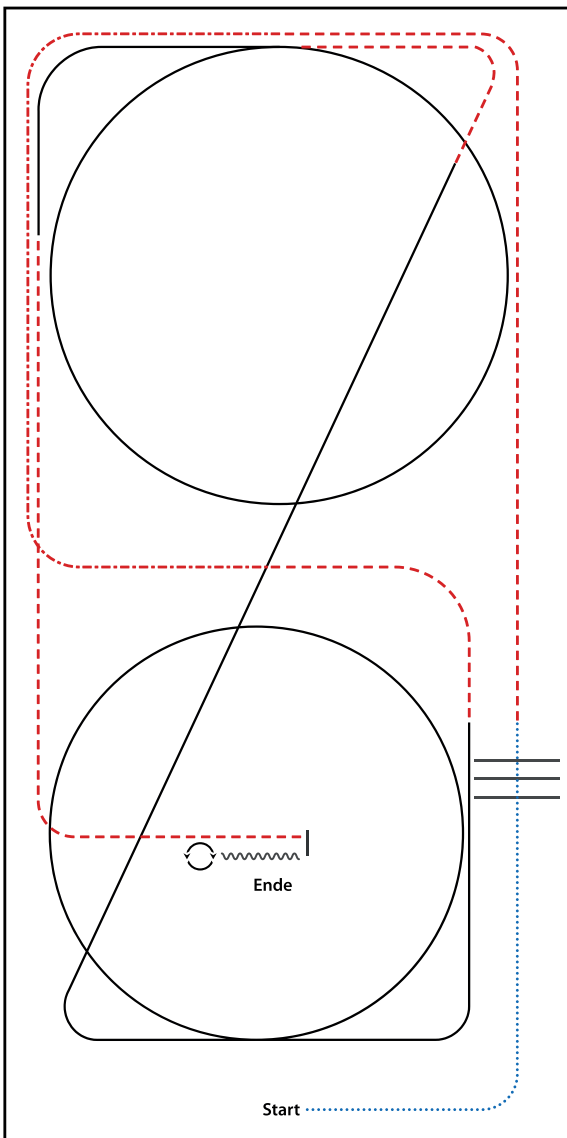

- 1) WALK,
- 2) WALK OVER, WALK
- 3) TROT
- 4) EXTENDED TROT CORNERS, TROT
- 5) LOPE (RL) CIRCLE, LOPE
- 6) TROT
- 7) LOPE (LL) CIRCLE
- 8) TROT
- 9) STOP, BACK UP
- 10) TURN 360° LEFT OR RIGHT

WALK (SCHRITT)	
EXTENDED WALK	
JOG/TROT (TRAB)	
EXTENDED TROT	
LOPE (GALOPP)	
EXTENDED LOPE	
BACK UP (RÜCKWÄRTS)	
LEAD CHANGE (GALOPPWECHSEL)	
TURN (DREHUNG)	
	ERSTE
	WESTENREITER
	UNION
	WELDFÖRDERNDE VERBÄNDE

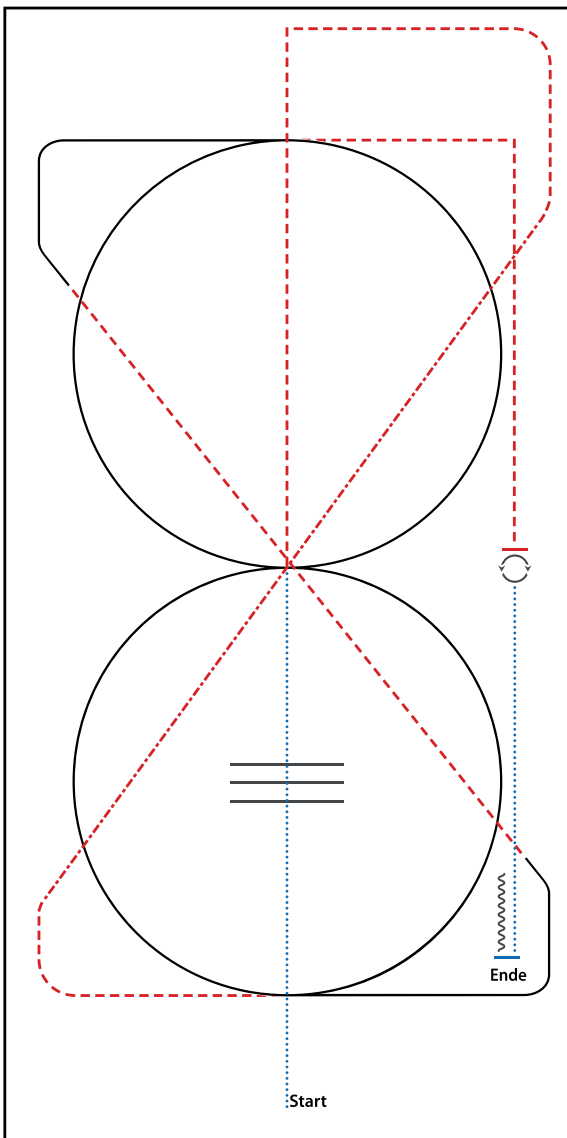

- 1) WALK
- 2) WALK OVER, WALK
- 3) TROT
- 4) EXTENDED TROT, TROT
- 5) LOPE (LL) CIRCLE, LOPE
- 6) TROT
- 7) LOPE (RL) CIRCLE
- 8) TROT
- 9) STOP, 360° TURN LEFT OR RIGHT
- 10) WALK
- 11) STOP, BACK UP

WALK (SCHRITT)	
EXTENDED WALK	
JOG/TROT (TRAB)	
EXTENDED TROT	
LOPE (GALOPP)	
EXTENDED LOPE	
BACK UP (RÜCKWÄRTS)	
LEAD CHANGE (GALOPPWECHSEL)	
TURN (DREHUNG)	
	ERSTE
	WESTENREITER
	UNION
	WESTENREITER

