

36. EWU-Turnier

Niedertaufkirchen-Hinteralbing

05./06.10.2024



SHERWOOD RANCH
Pferdepension ~ Guest-Ranch
Josef Fuchs
Pferdewirtschaftsmeister
★ ★ ★

Clinic Tools
Jackpot Ranch Riding
500,- € add.

Finale
Sherwood
3R-Cup 2024

ewu
Erste Westernreiterunion
Bayern e.V.



EWU-C-Turnier
Finale Sherwood-3R-Cup 2024
ClinicTools Jackpot RanchRiding

EWU – C-Turnier Niedertaufkirchen-Hinteralbing - Sherwoodranch

Turnierkategorie: EWU C-Turnier
Datum: 05. - 06.10.2024
Veranstaltungsort: Sherwoodranch, Hinteralbing 1, 84494 Niedertaufkirchen

Veranstalter: Josef Fuchs
Turnierorganisation/
Nennstelle: Volkhard Hummel - Tel.: 0170 380 25 52

Turnierleiter: Christine Hummel
Richter: Kathrin Brunner
Ringsteward: Sabine Kotzschmar
EWU-Steward: Maria Holz

Meldestelle: Stefan Pietsch – Tel.: 0151 - 68585446

Turniersprecher: Janina Löschner, Dirk Jungls
Doorman: Sigi Jahnel, Michael Stikar, Michi Haak
Parcoursdienst: Micha Hagendorn, Luna Schnitzler, Sophia
Schleifendienst: Hagendorn, Heike Kramer, Leni Demmelhuber, Luna
Schnitzler, Renate Lichtmannecker

Turniertierarzt: Marcus Menzel - Tel.: 0171 699 00 11
Sanitätsdienst: Nina Knapp - Tel.: 0151 445 15 979
Hufschmied: Ortwin Fincke – Tel.: 0171 218 68 51

Rettungsdienst: **112**

Turnierfotograf: Armin Pollak - www.arminpollak-fotografie.de

EWU - Steward: Maria Holz
0176-38266612

TURNIERFOTOGRAF - ARMIN POLLAK

EWU-C-TURNIER - 05./06.10.2024 - NIEDERTAUFKIRCHEN - SHERWOODRANCH

Armin Pollak
FOTOGRAFIE



SPONSORING FÜR DIESES TURNIER:

**JEDE STARTNUMMER
ERHÄLT EINE GUTSCHRIFT VON 5,-€
AUF EINE BILDERBESTELLUNG**

**AUßERDEM GIBT ES NOCH 5 GUTSCHEINE A 20.-€
FÜR EINE BILDERBESTELLUNG ZU GEWINNEN**

**EWU-Turnier: C-Turnier II/24 Niedertaufkirchen
84494 Niedertaufkirchen, Hinteralbing 1**

Zeitplan

Anreise zum Turnier ist am 04.10. ab 16:00 Uhr möglich - vorher stehen die Boxen und Paddocks nicht zur Verfügung

Öffnungszeiten der Meldestelle

04.10.2024: 16:00 - 19:00

05.10.2024: 07:00 - 18:00

06.10.2024: 06:00 - Turnierende

Abreitezeiten

04.10.2024: 17:00 - 20:00

05.10.2024: 07:00 - 18:00

06.10.2024: 06:00 - Turnierende

05.10.2024

Gr. Reithalle

08:00	-	08:15	Greenhorse Pleasure	Nennungen: 4
08:15	-	08:30	Walk Trot Pleasure	Nennungen: 7
08:30	-	08:50	LK 1/2 Western Pleasure	Nennungen: 13
08:50	-	09:15	LK 4A Western Ranch Rail - Sherwood 3R-Cup 2024	Nennungen: 18
09:15	-	09:25	LK 4B Western Ranch Rail - Sherwood 3R-Cup 2024	Nennungen: 6
09:25	-	09:50	LK 3 Western Ranch Rail - Sherwood 3R-Cup 2024	Nennungen: 16
09:50	-	10:30	LK 1/2 Western Horsemanship	Nennungen: 15
10:30	-	10:45	LK 5 Western Pleasure	Nennungen: 5
10:45	-	11:05	LK 4A Western Pleasure	Nennungen: 11
11:05	-	11:20	LK 4B Western Pleasure	Nennungen: 6
11:20	-	11:40	LK 3 Western Pleasure	Nennungen: 13
11:40	-	12:00	Greenhorse Ranch Riding	Nennungen: 7
12:00	-	12:30	Pause	
12:30	-	13:20	LK 4A Ranch Riding - Sherwood 3R-Cup 2024	Nennungen: 20
13:20	-	13:35	LK 4B Ranch Riding - Sherwood 3R-Cup 2024	Nennungen: 6
13:35	-	14:15	LK 3A Ranch Riding - Sherwood 3R-Cup 2024	Nennungen: 16
14:15	-	14:30	LK 3B Ranch Riding - Sherwood 3R-Cup 2024	Nennungen: 5
14:30	-	15:10	LK 2 Ranch Riding	Nennungen: 16
15:10	-	15:25	LK 1 Ranch Riding	Nennungen: 4
15:25	-	15:45	LK 4A Reining - Sherwood 3R-Cup 2024	Nennungen: 4
15:45	-	16:05	LK 4B Reining - Sherwood 3R-Cup 2024	Nennungen: 4
16:05	-	16:25	LK 3 Reining - Sherwood 3R-Cup 2024	Nennungen: 5
16:25			Getränke-Pleasure LK 3/4	Nennungen: 11
anschl.			Getränke-Pleasure LK 1/2	Nennungen: 14

anschl. Aufbau Trail-Parcour - Abnahme durch die RichterIn
 anschl. Trail-Parcour für 30 Min. zum Abgehen für alle LK frei gegeben
 19:30 Siegerehrung "Sherwood 3R-Cup 2024" im Innenhof der Sherwoodranch beim Reiterstüberl

06.10.2024

Gr. Reithalle

06:00		Trail-Parcour für 30 Min. zum Abgehen für alle LK frei gegeben	
06:30		Aufbau Trail-Parcour für die 1. Prüfung durch die Parcourmanschaft	
07:00	- 07:20	Greenhorse Trail	Nennungen: 5
07:20	- 08:05	LK 1/2 Trail	Nennungen: 13
08:05	- 08:50	LK 3A Trail	Nennungen: 15
08:50	- 09:05	LK 3B Trail	Nennungen: 4
09:05	- 09:50	LK 4/5A Trail	Nennungen: 15
09:50	- 10:20	LK 4/5B Trail	Nennungen: 10
10:20	- 10:45	Walk Trot Trail	Nennungen: 7
10:45	- 11:05	LK 1-3 Showmanship at Halter	Nennungen: 7
11:05	- 11:35	LK 4/5 Showmanship at Halter	Nennungen: 12
11:35	- 12:05	Führzügelklasse	Nennungen: 11
12:05	- 12:35	Pause	
12:35	- 12:45	LK 5 Western Ranch Rail	Nennungen: 4
anschl.		LK 1/2 Reining	Nennungen: 9
anschl.		Greenhorse Horsemanship	Nennungen: 4
anschl.		Walk Trot Horsemanship Erwachsene	Nennungen: 4
anschl.		Walk Trot Horsemanship Jugend	Nennungen: 9
anschl.		LK 5 Western Horsemanship	Nennungen: 9
anschl.		LK 4B Western Horsemanship	Nennungen: 7
anschl.		LK 4A Western Horsemanship	Nennungen: 13
anschl.		LK 3A Western Horsemanship	Nennungen: 15
anschl.		LK 3B Western Horsemanship	Nennungen: 4
anschl.		ClinicTools Jackpot RanchRiding - 500 € added	Nennungen: 26
anschl.		Walk Trot Ranch Riding	Nennungen: 9
anschl.		LK 5 Ranch Riding	Nennungen: 7
anschl.		LK 1/2 Western Ranch Rail	Nennungen: 13

Sponsor der Jackpot RanchRiding:



ClinicTools

Preisgeld: 500,- € add.

Preisgeldverteilung: Platz 1 - 5 = 30%, 25%, 20%, 15%, 10%
Auszahlung nach der Siegerehrung in BAR an der Meldestelle

Unser Hauptsponsor

AUCH BEI DIESEM TURNIER WIEDER MIT DABEI







alex mundorff
western riding & country lifestyle

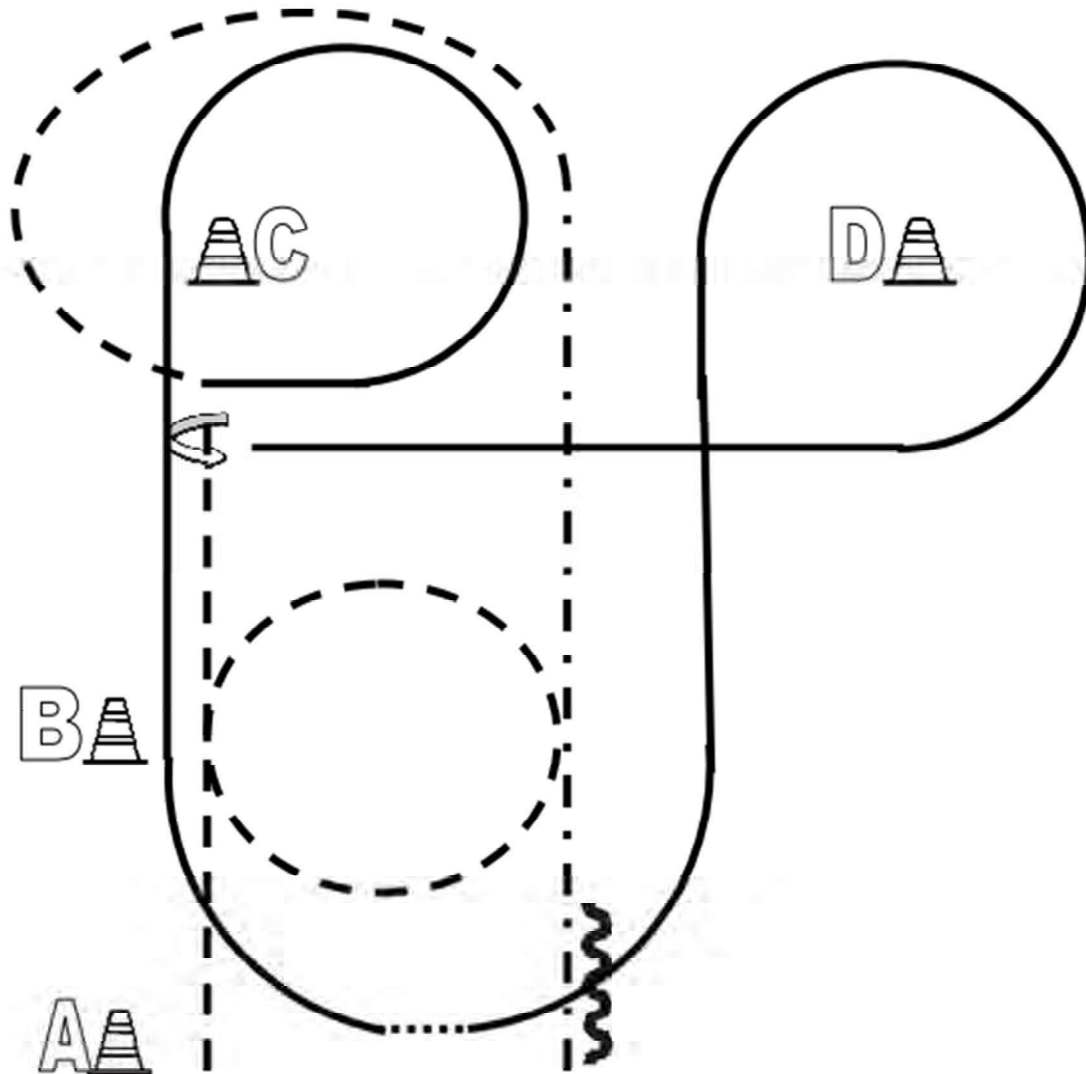

Western Horsemanship LK 1 / 2



1. Beginnend aus dem Stand Jog, bei B Jogvolte rechts
Kurz vor C anhalten
270° HHW links
2. Lope links und Volte links um D
Einf. Wechsel über Walk
Lope rechts, Lopevolte rechts um C
3. Um C Jog
Auf Höhe C extended Jog
Höhe A Stop, mind. 1 Pferdelänge rückwärtsrichten
Im Walk zurück ins Line Up.

	Back Up
	Walk
	Jog
	Lope
	Wechsel

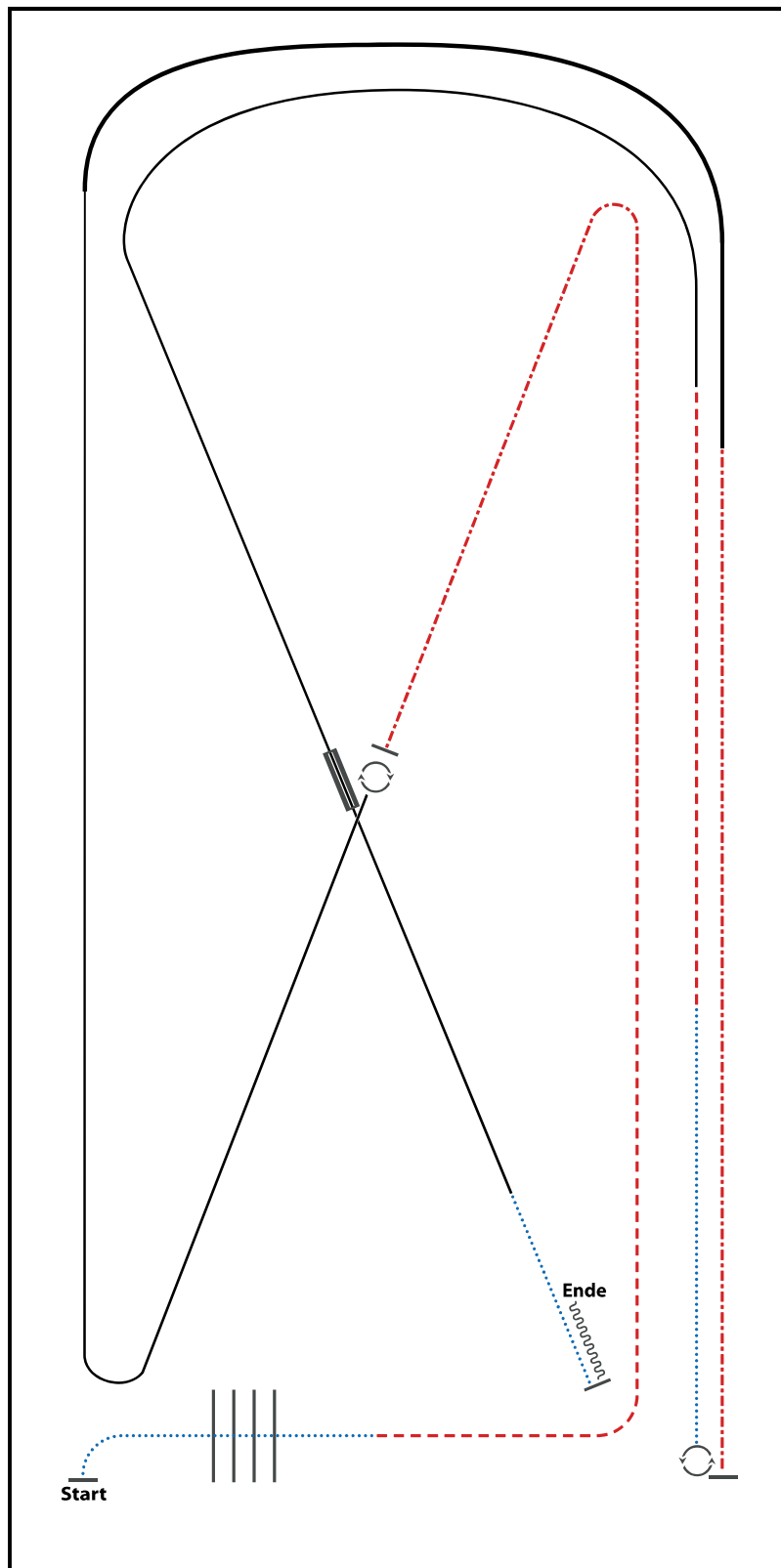

- 1) WALK OVER
- 2) TROT
- 3) EXTENDED TROT
- 4) STOP, 360° TURN RIGHT
- 5) LOPE (RL)
- 6) EXTENDED LOPE (RL), LOPE (RL)
- 7) EXTENDED TROT
- 8) STOP, 540° TURN LEFT
- 9) WALK
- 10) TROT
- 11) LOPE (LL)
- 12) CHANGE LEADS (SIMPLE OR FLYING), LOPE (RL)
- 13) WALK, STOP, BACK UP

WALK (SCHRITT)	
EXTENDED WALK	
JOG/TROT (TRAB)	
EXTENDED TROT	
LOPE (GALOPP)	
EXTENDED LOPE	
BACK UP (RÜCKWÄRTS)	
LEAD CHANGE (GALOPPWECHSEL)	
TURN (DREHUNG)	

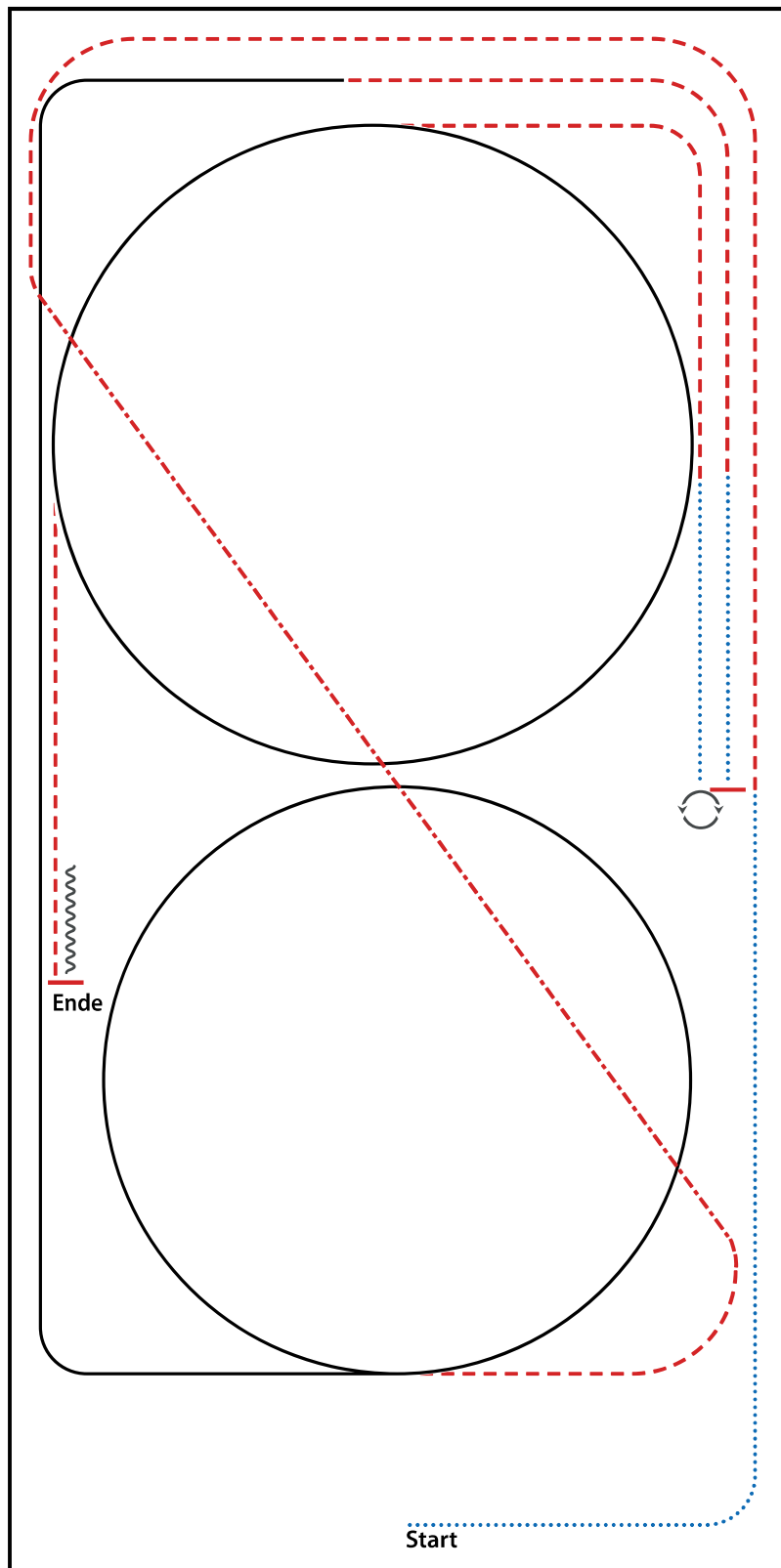

- 1) WALK
- 2) TROT
- 3) EXTENDED TROT, TROT
- 4) LOPE (RL) CIRCLE, LOPE
- 5) TROT
- 6) WALK
- 7) STOP, 540° TURN RIGHT OR LEFT
- 8) WALK
- 9) TROT
- 10) LOPE (LL) CIRCLE
- 11) TROT
- 12) STOP, BACK UP

WALK (SCHRITT)	
EXTENDED WALK	
JOG/TROT (TRAB)	
EXTENDED TROT	
LOPE (GALOPP)	
EXTENDED LOPE	
BACK UP (RÜCKWÄRTS)	
LEAD CHANGE (GALOPPWECHSEL)	
TURN (DREHUNG)	

ERSTE WESTERNREITER UNION
 FÖRDERBUND WESTERNREITEN

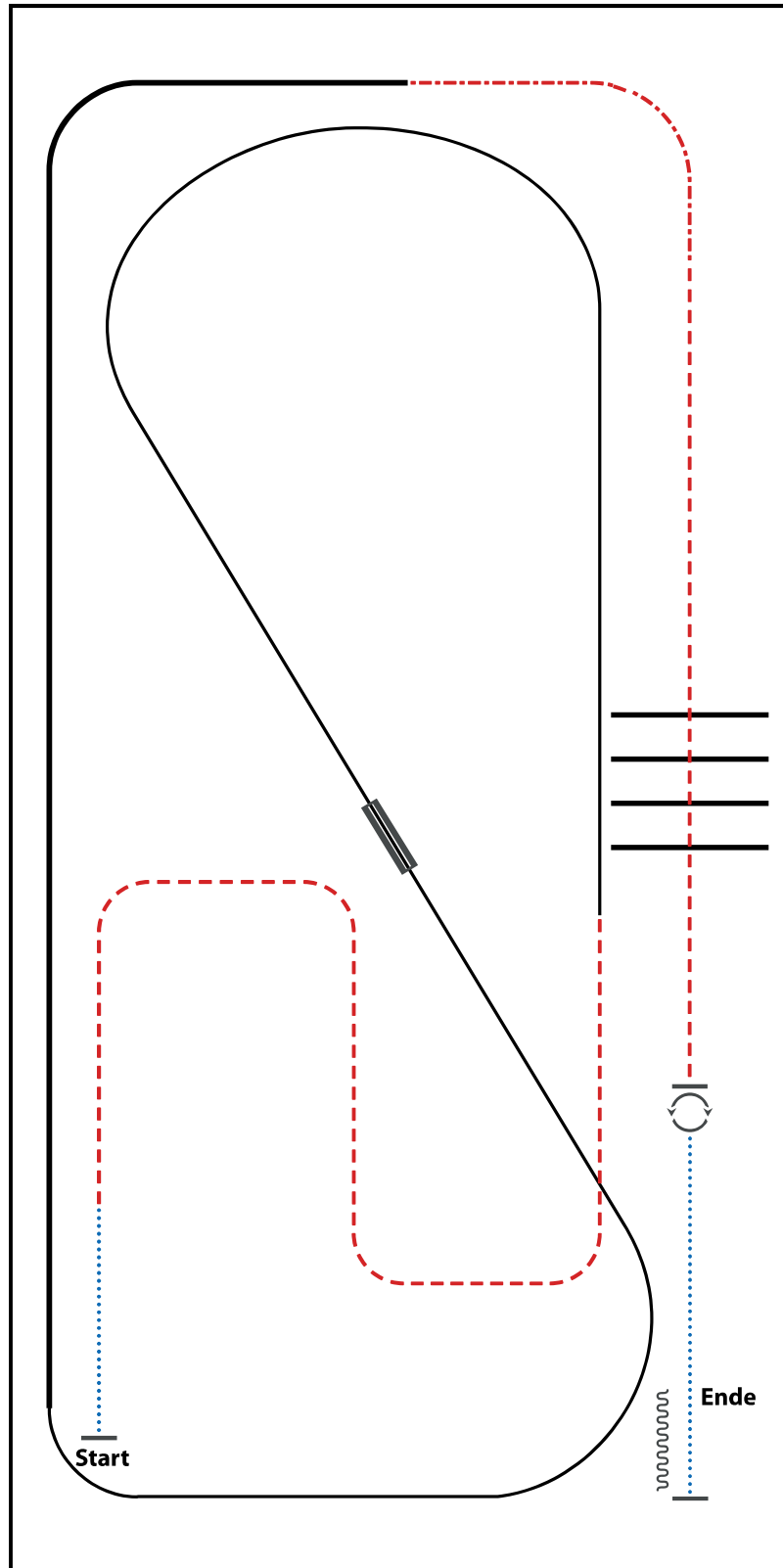

- 1) WALK
- 2) TROT
- 3) LOPE (LL)
- 4) CHANGE LEADS (SIMPLE OR FLYING)
- 5) LOPE (RL)
- 6) EXTENDED LOPE (RL)
- 7) EXTENDED TROT
- 8) TROT
- 9) TROT OVER
- 10) STOP, TURNS 360° (EACH DIRECTION)
- 11) WALK, STOP, BACK UP

WALK (SCHRITT)	
EXTENDED WALK	
JOG/TROT (TRAB)	
EXTENDED TROT	
LOPE (GALOPP)	
EXTENDED LOPE	
BACK UP (RÜCKWÄRTS)	
LEAD CHANGE (GALOPPWECHSEL)	
TURN (DREHUNG)	
ERSTE WESTERNREITER UNION FÜR DEN SÜDWESTDEUTSCHEN WESTERNREITEN	

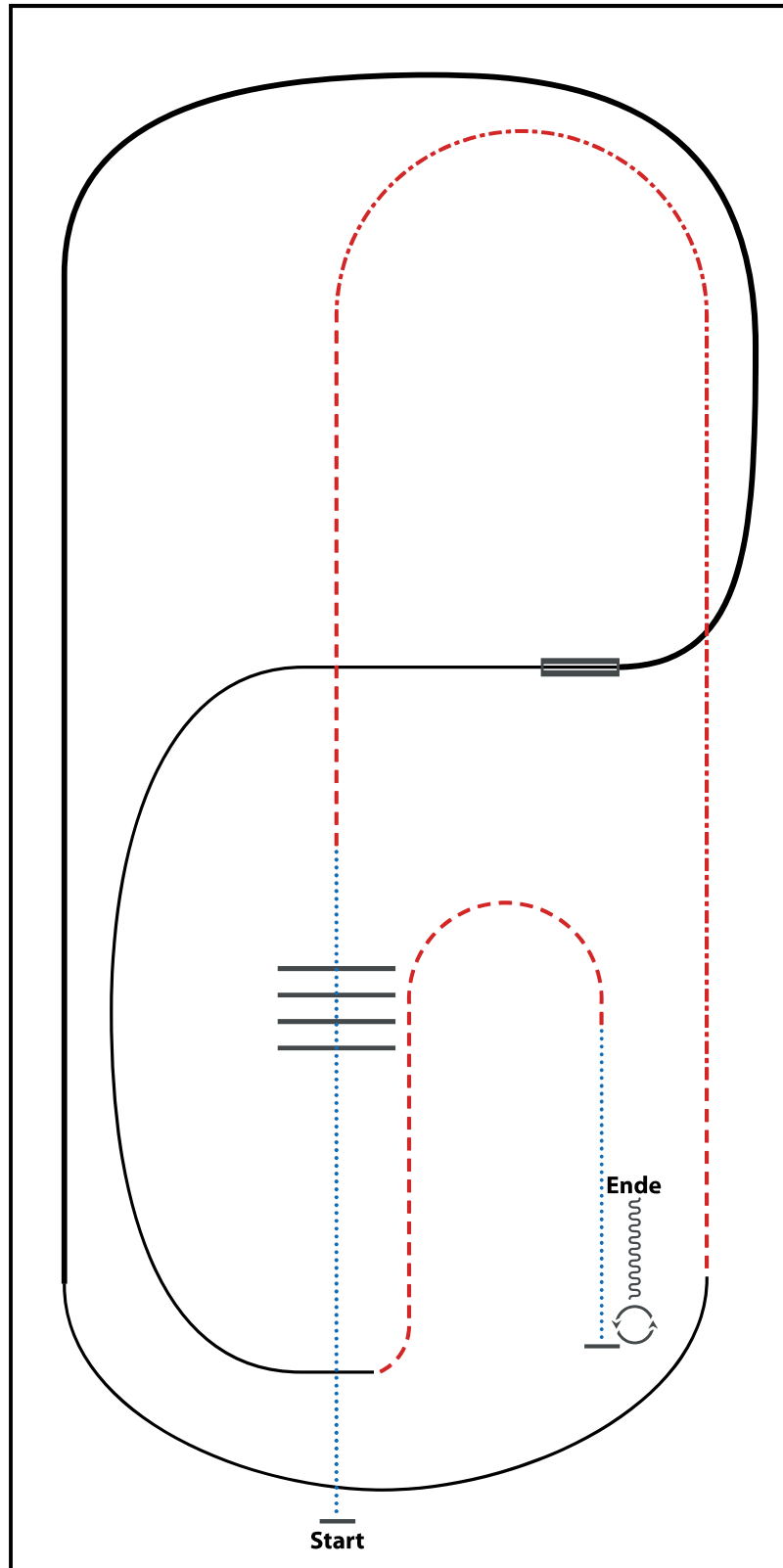

- 1) WALK OVER
- 2) TROT
- 3) EXTENDED TROT, TROT
- 4) LOPE (RL)
- 5) EXTENDED LOPE (RL)
- 6) CHANGE LEADS (SIMPLE OR FLYING)
- 7) LOPE (LL)
- 8) TROT
- 9) WALK
- 10) STOP, TURNS 360° (EACH DIRECTION)
- 11) BACK UP

WALK (SCHRITT)	
EXTENDED WALK	
JOG/TROT (TRAB)	
EXTENDED TROT	
LOPE (GALOPP)	
EXTENDED LOPE	
BACK UP (RÜCKWÄRTS)	
LEAD CHANGE (GALOPPWECHSEL)	
TURN (DREHUNG)	

ERSTE WESTERNREITER UNION FÖRDERBUND WESTERNREITEN

Beim Turnier mit Verkaufsstand vor Ort:



Showoutfits für...

Kids, Teens & Erwachsene,

Leadline Klassen, DIY-Oberteile,

Mutter/Tochter Kombinationen und

Jungen Hemden

Showoutfit-Schnittmuster für...

Mädchen & Damen

Westernaccessoire & Turnierhelfer

WWW.SHOWYOU.DE INFO@SHOWYOU.DE

Reining Pattern 14 - LK 4A - LK 4B

Reining

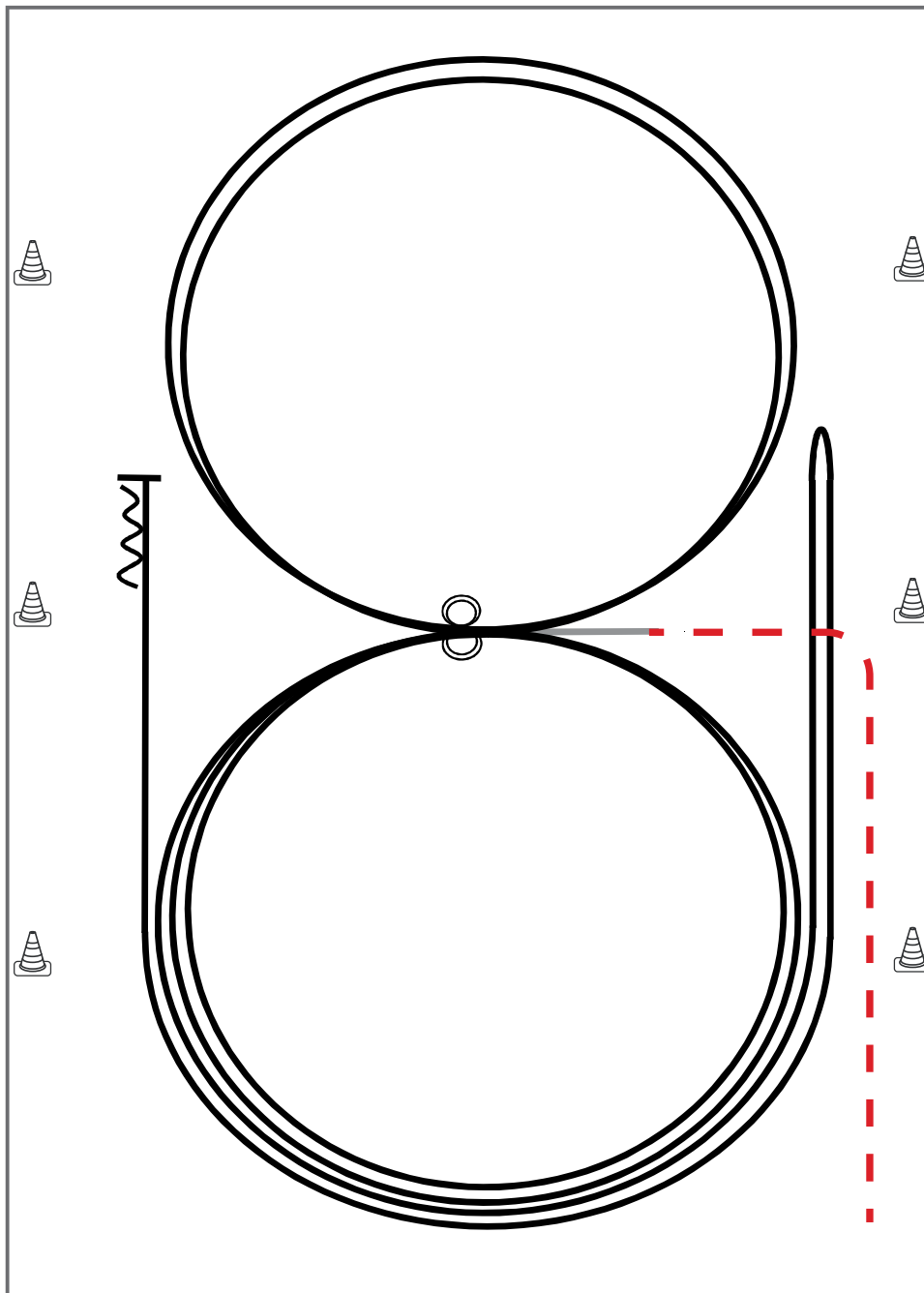

Im Trab zur Mitte der Bahn.

Beginn der Aufgabe aus dem Schritt oder aus dem Stand.

- 1) 2 Zirkel Galopp (**links**), Stop bei X, Verharren
- 2) 2 Spins **links**, Verharren
- 3) 2 Zirkel Galopp (**rechts**), Stop bei X, Verharren
- 4) 2 Spins **rechts**, Verharren
- 5) Galopp (**links**) auf dem Zirkel, der nicht geschlossen wird, Run Down entlang der langen Seite, Stop mind. 6,00 m von der Bande entfernt hinter dem **Mittelmarker**, Rollback **rechts**, kein Verharren
- 6) Galopp (**rechts**) auf dem Zirkel, der nicht geschlossen wird, Run Down entlang der langen Seite, Stop mind. 6,00 m von der Bande entfernt hinter dem **Mittelmarker**, Rückwärtsrichten mind. 3,00 m, Verharren

Trab	---
Galopp	—
Rückwärts	⋈

Der Reiter muss das Kopfstück zur Gebisskontrolle vor dem Richter abnehmen.

Reining Pattern 13 - LK 3

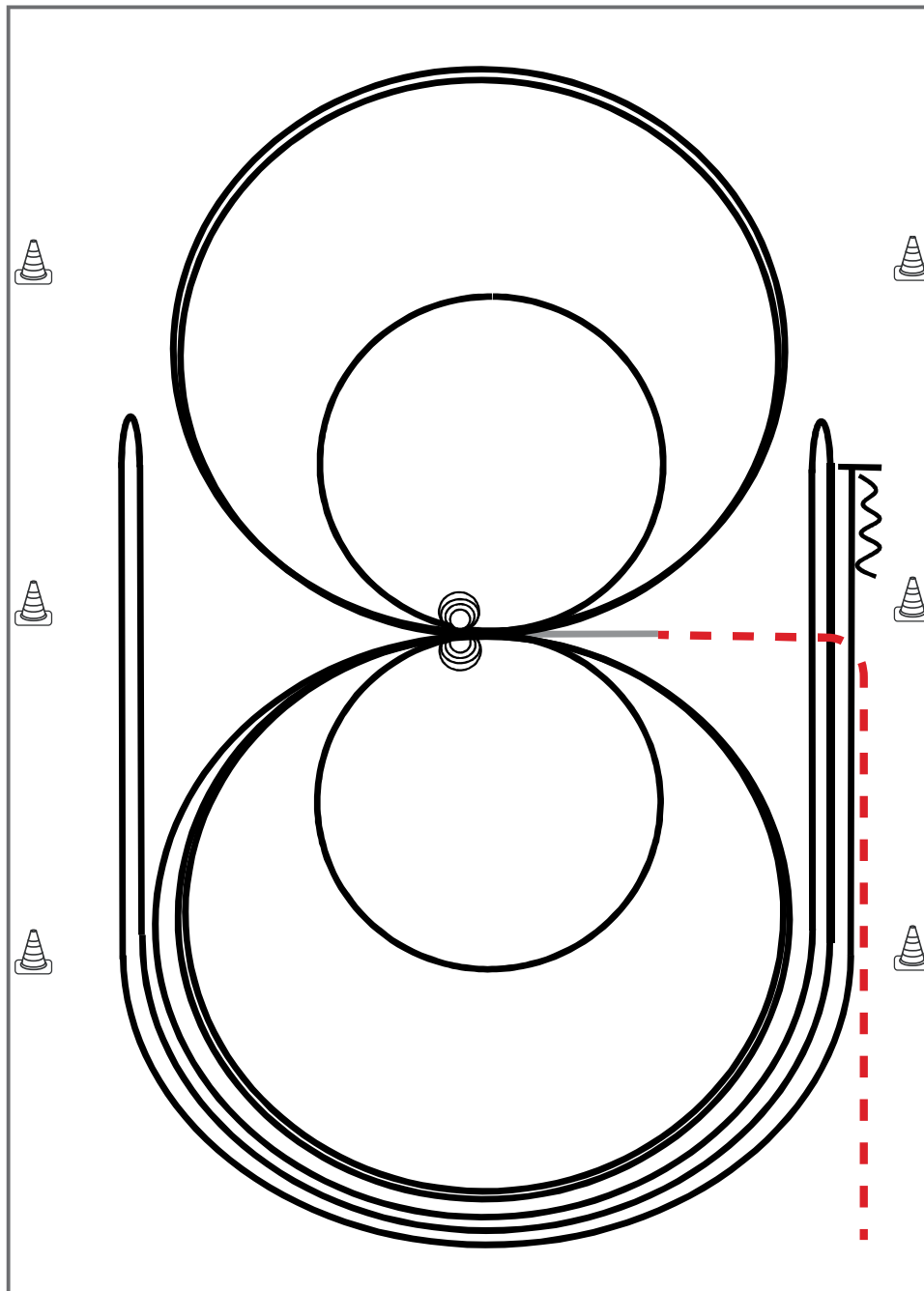

Im Trab zur Mitte der Bahn. Beginn der Aufgabe aus dem Schritt oder aus dem Stand.

- 1) 2 Zirkel Galopp (**links**), 1. groß und schnell, **2. klein** und langsam, Stop bei X
- 2) 4 Spins **links**, Verharren
- 3) 2 Zirkel Galopp (**rechts**), 1. groß und schnell, **2. klein** und langsam, Stop bei X
- 4) 4 Spins **rechts**, Verharren
- 5) 1 Zirkel Galopp (**links**) groß und schnell, Galoppwechsel bei X, 1 Zirkel Galopp (**rechts**) groß und schnell, Galoppwechsel bei X (figure 8)
- 6) Galopp (**links**) auf dem Zirkel, der nicht geschlossen wird, Run Down entlang der langen Seite, Sliding Stop mind. 6,00 m von der Bande entfernt hinter dem **Mittelmarker**, Rollback **rechts**, kein Verharren
- 7) Galopp (**rechts**) auf dem Zirkel, der nicht geschlossen wird, Run Down entlang der langen Seite, Sliding Stop mind. 6,00 m von der Bande entfernt hinter dem **Mittelmarker**, Rollback **links**, kein Verharren
- 8) Galopp (**links**) auf dem Zirkel, der nicht geschlossen wird, Run Down entlang der langen Seite, Sliding Stop mind. 6,00 m von der Bande entfernt hinter dem **Mittelmarker**, Rückwärtsrichten mind. 3,00 m, Verharren

Der Reiter muss das Kopfstück zur Gebisskontrolle vor dem Richter abnehmen.

Trab	---
Galopp	—
Rückwärts	~~~~~



www.carat-automaten.de

Alles rund ums Pferd
www.RASP-Online.de



Pattern Trail – Greenhorse

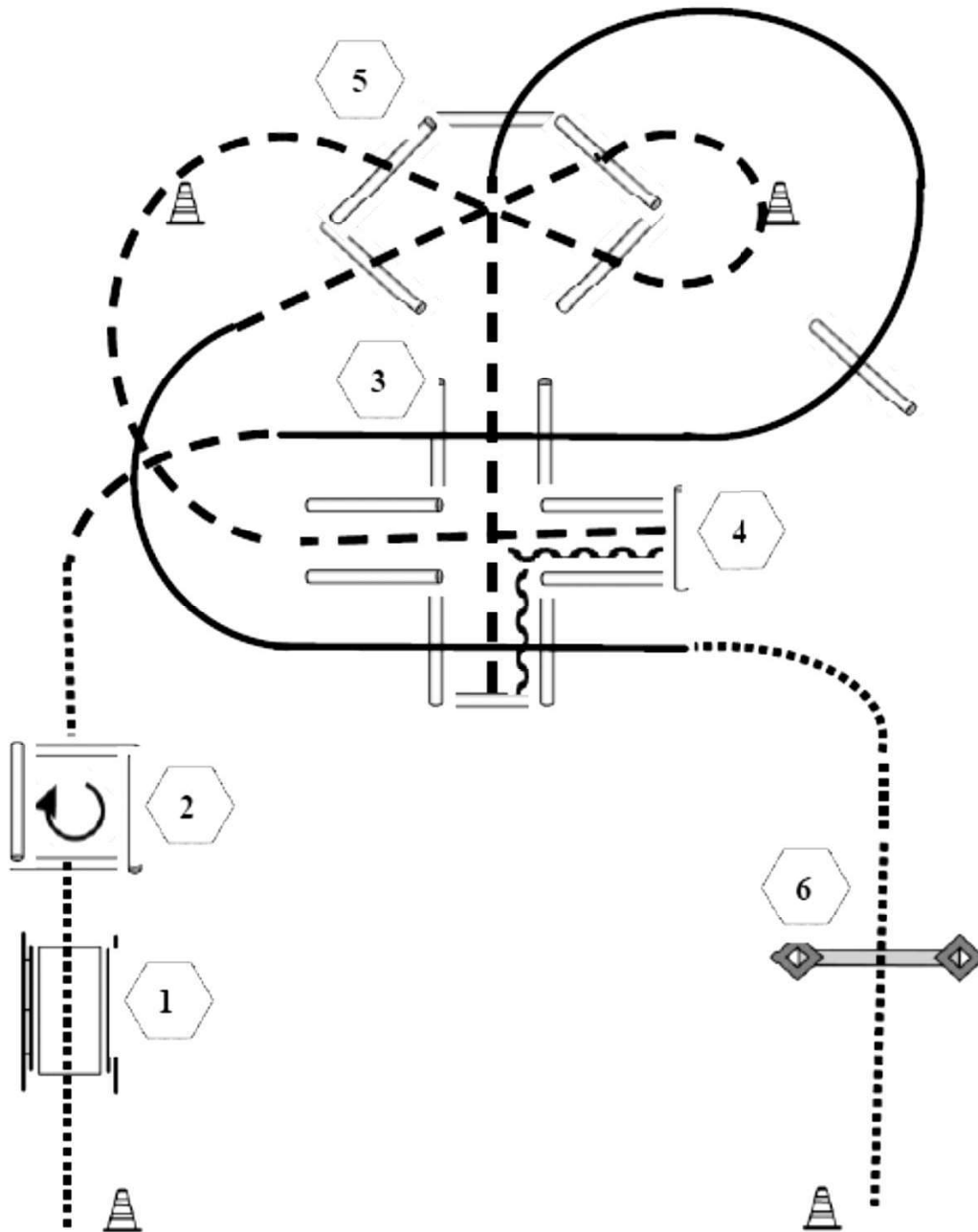

- (1) Brücke
- (2) Walk in Box, 360° Turn rechts, Walk out
- (3) Lope over
- (4) Jog in, Back up, Jog out
- (5) Jog over, Lope over
- (6) Tor

Pattern Trail -- LK 1/2 -

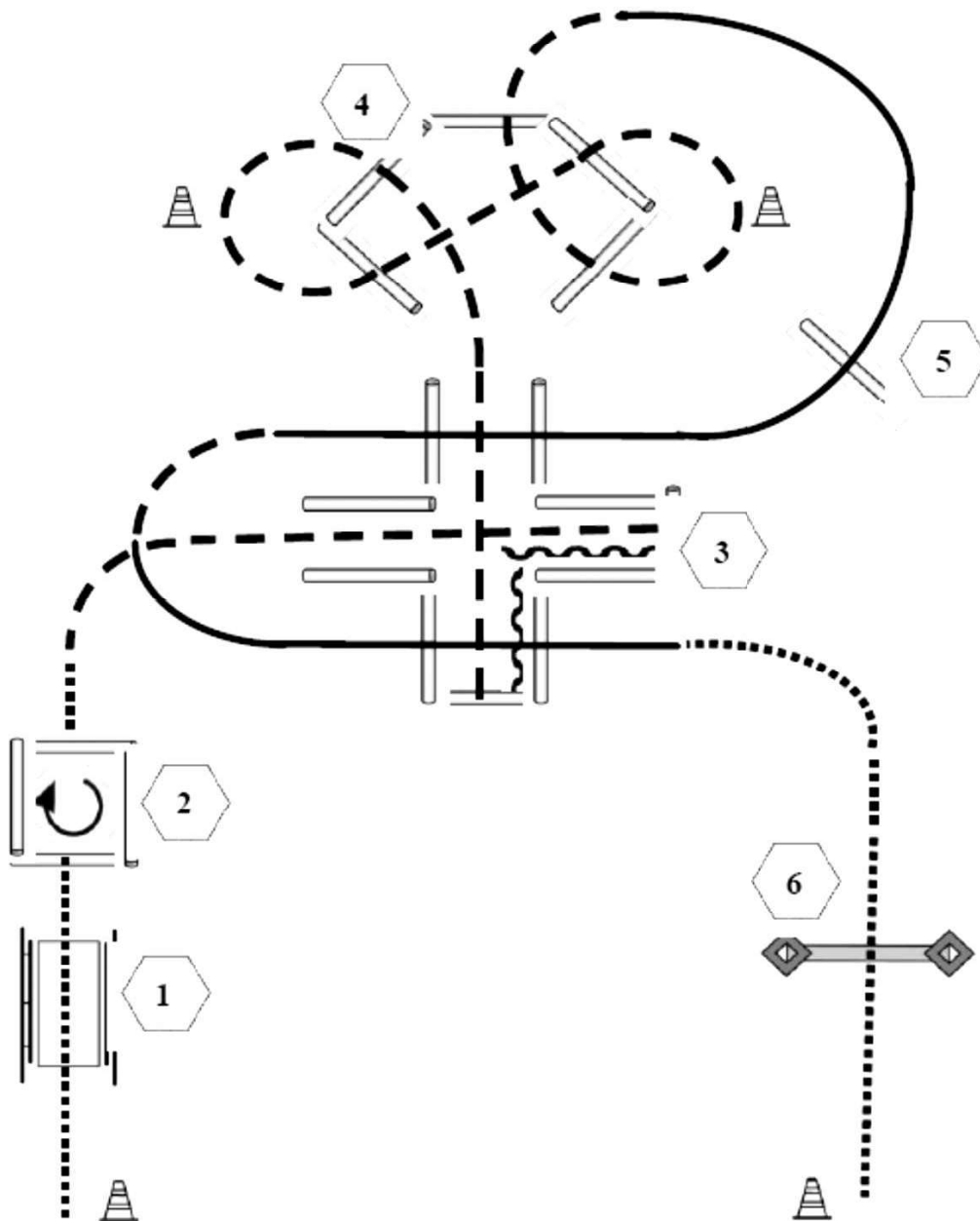

- (1) Brücke
- (2) Walk in Box, 360° Turn rechts, Walk out
- (3) Jog in, Back up, Jog out
- (4) Jog over
- (5) Lope over, einfacher Wechsel über Trab, Lope over
- (6) Tor

Pattern Trail – LK 3A - LK 3B

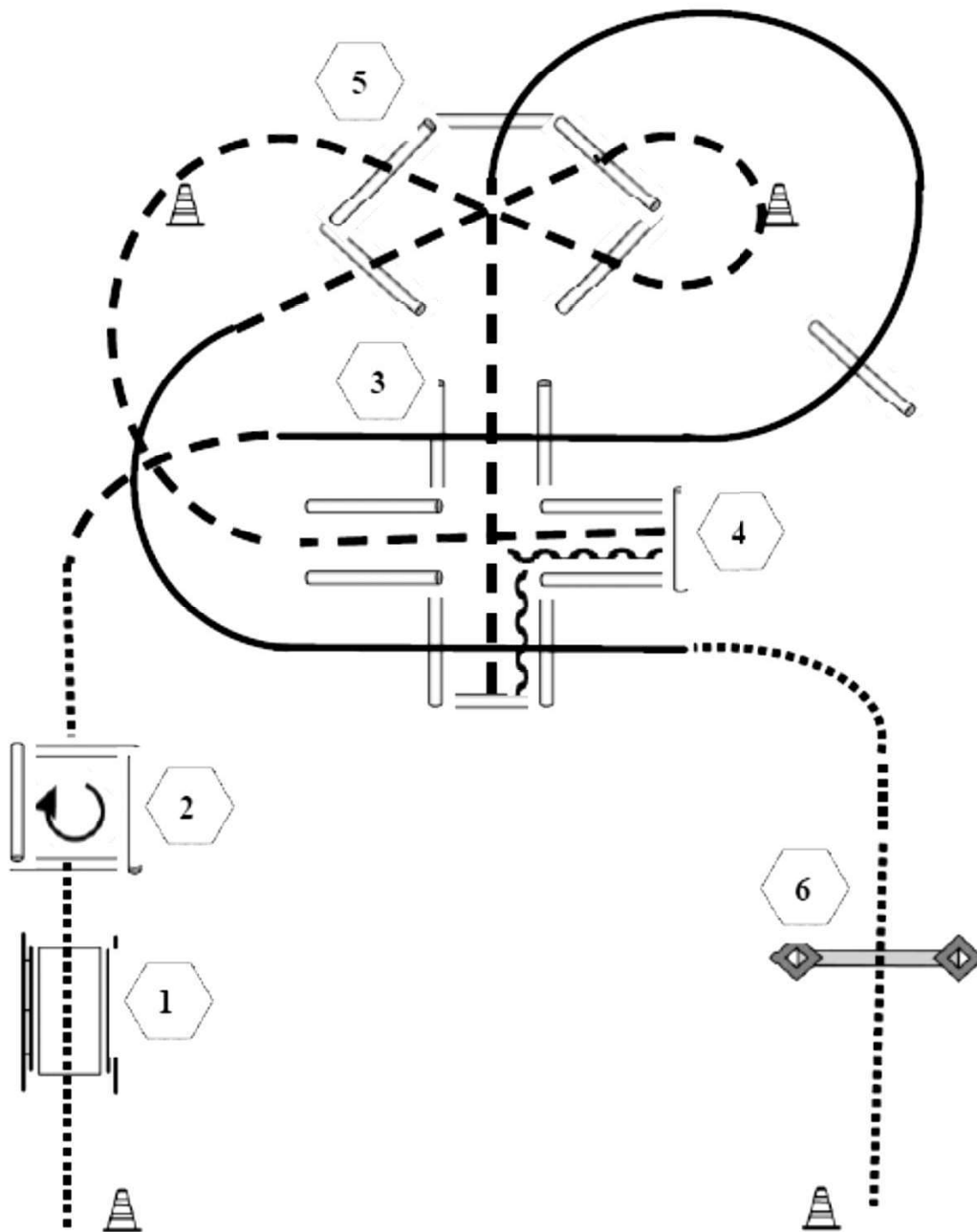

- (1) Brücke
- (2) Walk in Box, 360° Turn rechts, Walk out
- (3) Lope over
- (4) Jog in, Back up, Jog out
- (5) Jog over, Lope over
- (6) Tor

Pattern Trail – LK 4/5A und LK 4/5B

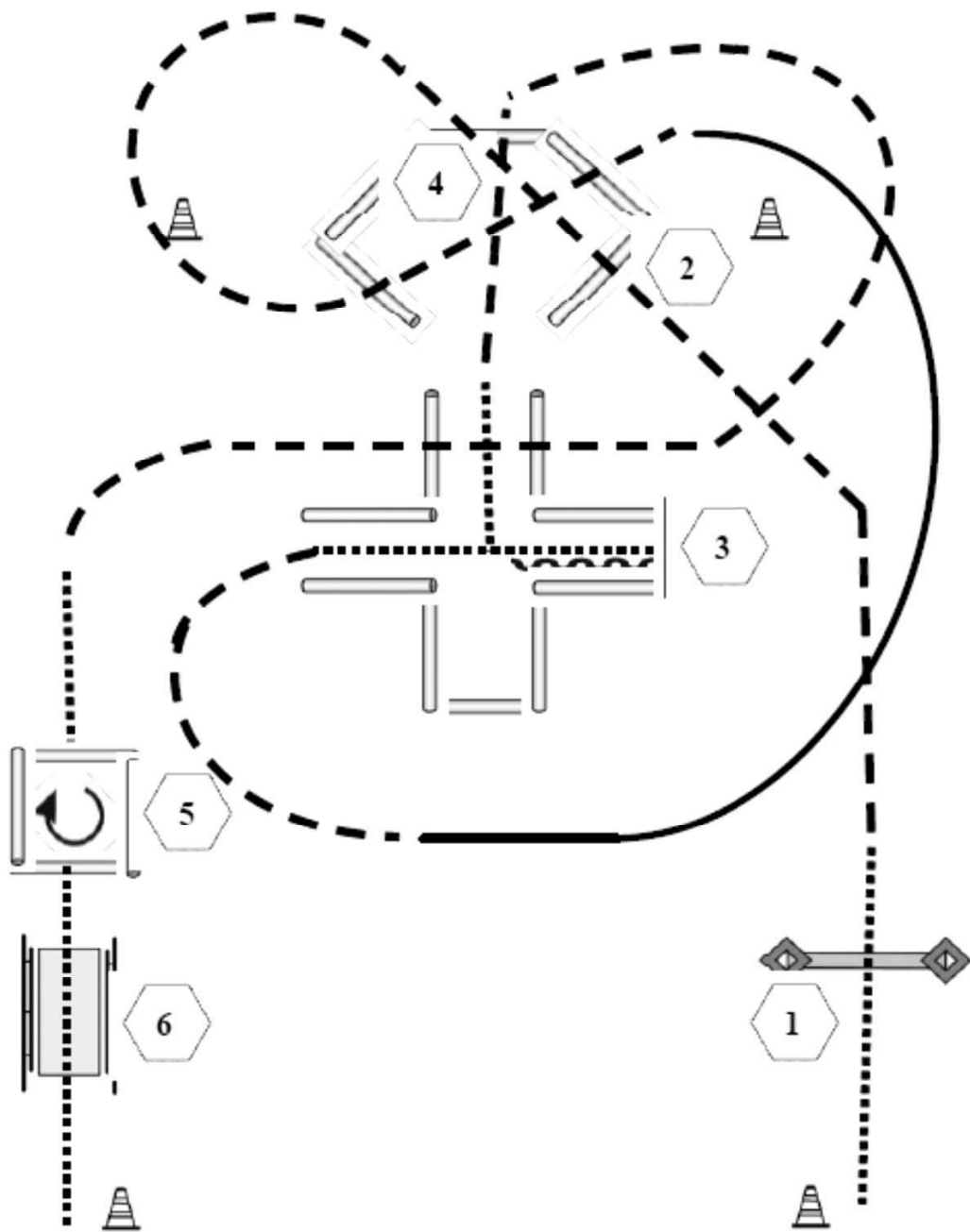

- (1) Tor
- (2) Jog over
- (3) Walk in, Back up, Walk out
- (4) Jog over
- (5) Walk in Box, 360° Turn rechts, Walk out
- (6) Brücke

Trail Walk Trot

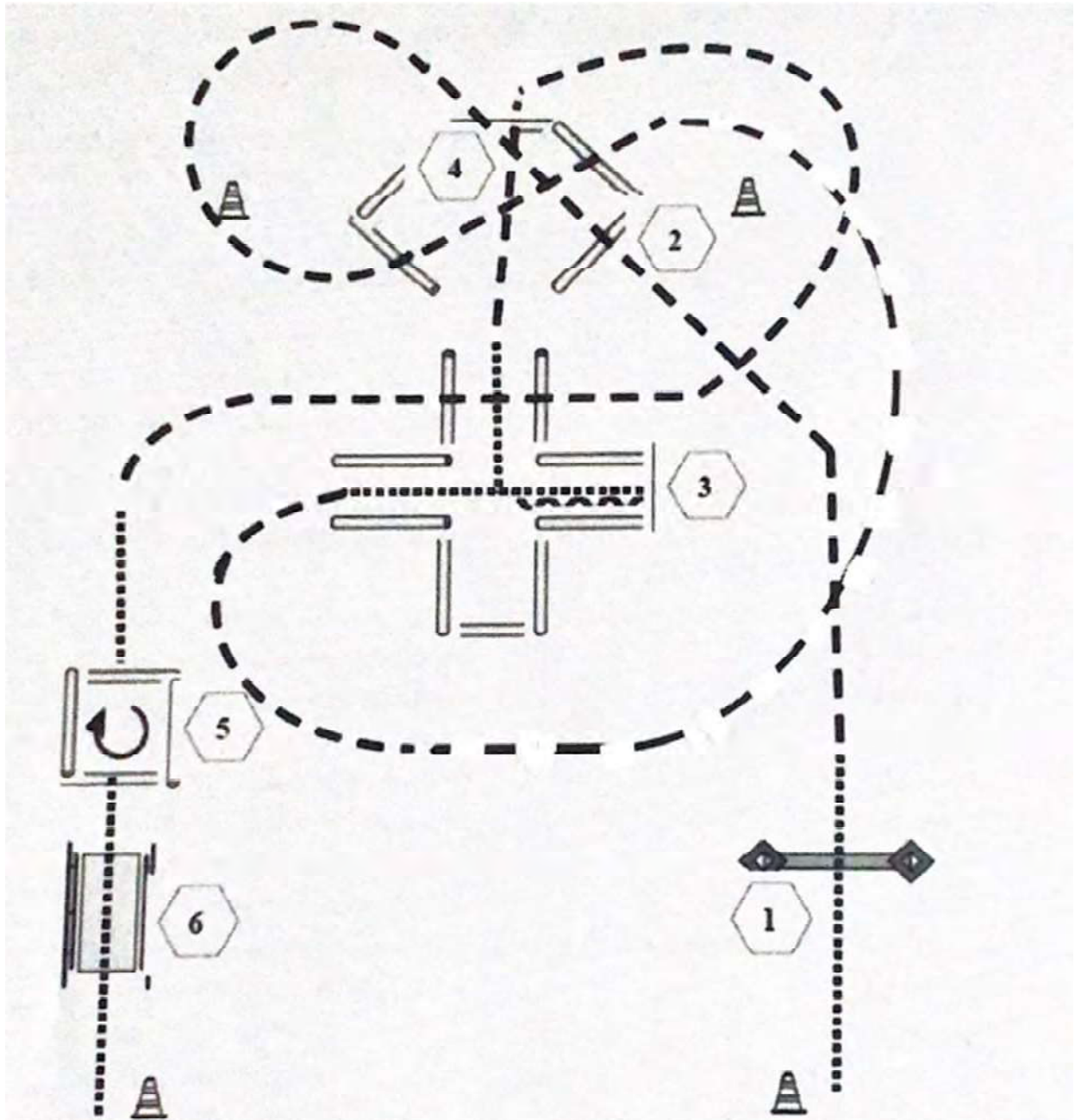

- (1) Tor
- (2) Jog over
- (3) Walk in, Back up, Walk out
- (4) Jog over
- (5) Walk in Box, 360° Turn rechts, Walk out
- (6) Brücke



ALLES RUND UMS BOSAL

Wir von Bosalino sind mit unserem Verkaufsstand beim EWU-C-Turnier auf der Sherwoodranch für euch da! Wir haben eine große Auswahl an Bosals dabei, die ihr testen könnt.

Natürlich gibt es bei uns auch Mecaten, Bosal-Hanger, Leadrope-Hanger, Halfter, Knotenhalfter, Bodenarbeitsseile und vieles mehr aus eigener Herstellung.



KURSE
BERATUNG
ANPASSUNG

WWW.PHIL-HIPPOS.DE
WWW.BOSALINO.COM

Pattern Showmanship at Halter - LK 1-3

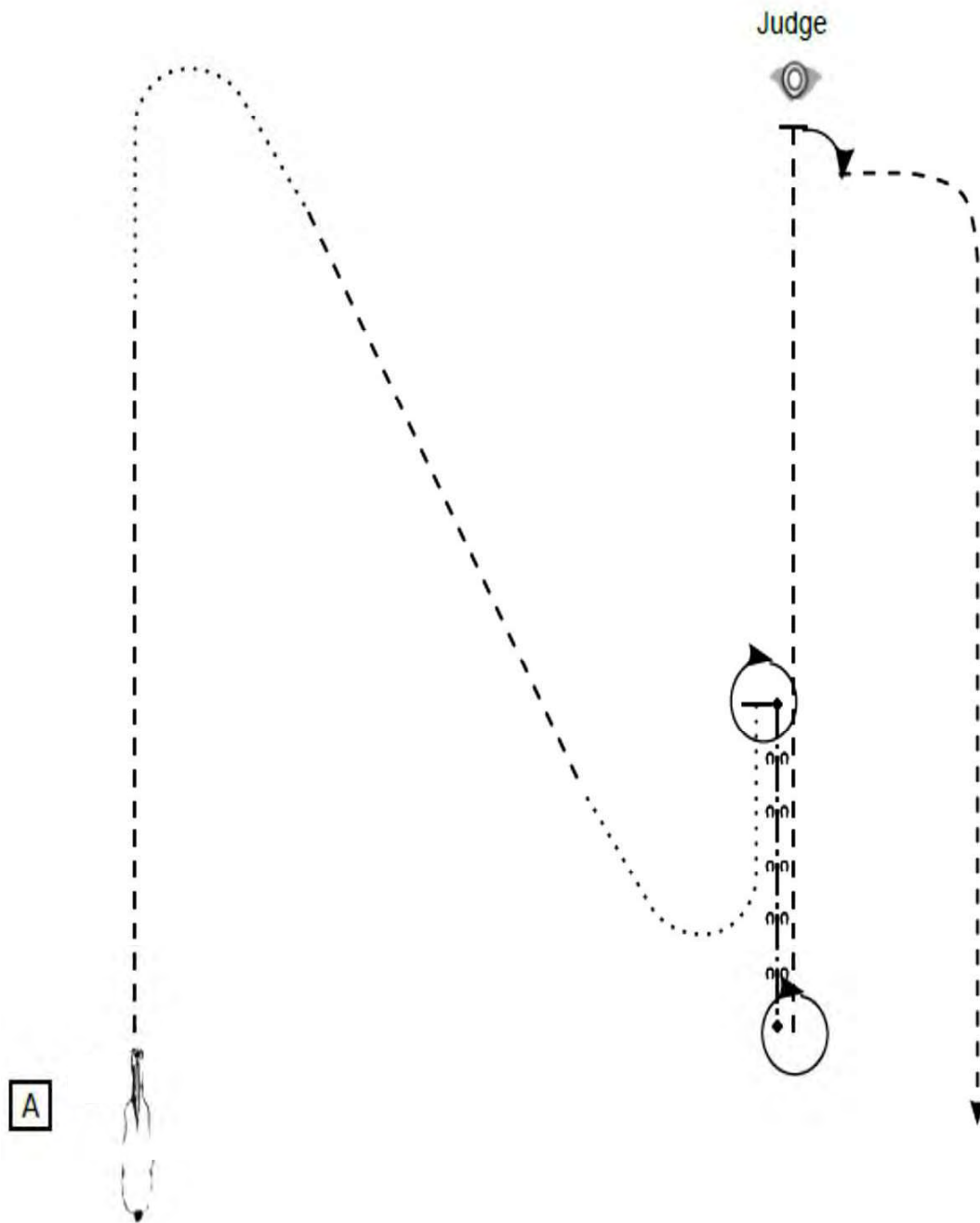

- Start bei A/Aufstellung
- (1) Trot, Walk
 - (2) Trot, Walk, Stop
 - (3) Turn 360°
 - (4) Back up
 - (5) Turn 360°
 - (6) Trot, Stop
 - (7) Set Up
 - (8) Inspection
 - (9) Turn 90°, Trot
- Im Trot die Arena verlassen

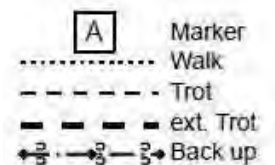

Showmanship at Halter LK 4/5

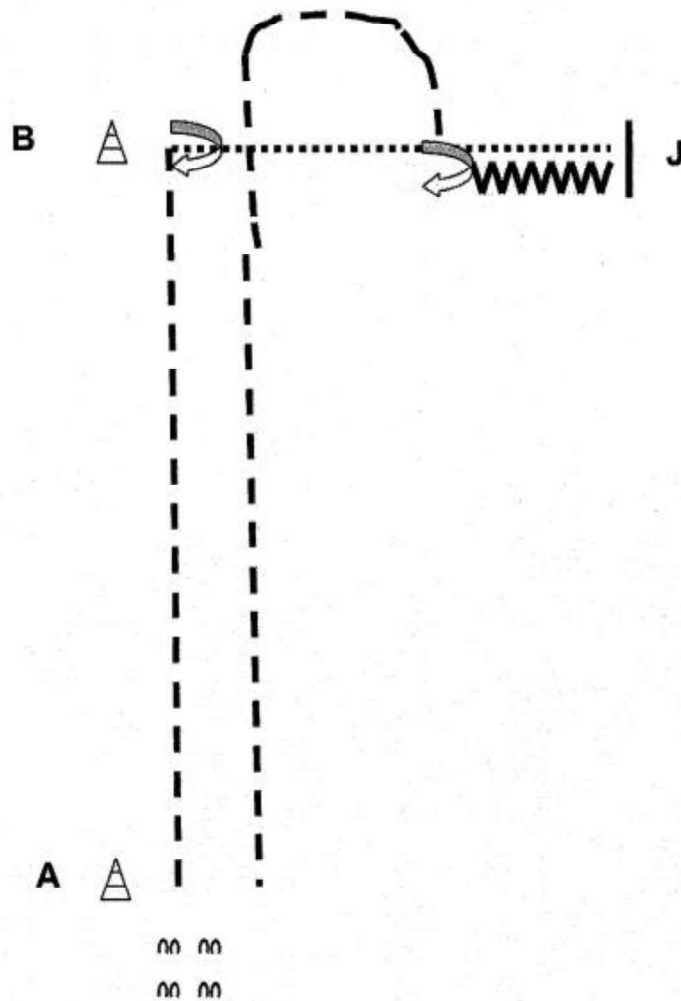

1. Be ready at A
2. Jog to B
3. Turn 90°
4. Walk to Judge
5. Set up for inspection
6. After Set up back up 5 steps
7. Turn 270° and jog away

A[®] BERUFSKLEIDUNG USWEGER -TEXTILSTICKEREI-

Rennbahnstraße 3 84323 Massing
www.ausweger.de ausweger@t-online.de

Tel. 08724/1750
Fax 08724/8324



BP.

HAKRO
ACTIVEWEAR

CLIQUE
REG. TRADEMARK

Printer
ACTIVE WEAR



www.Muehdorfer-Pferdefutter.de

Führzügelklasse Niedertaufkirchen

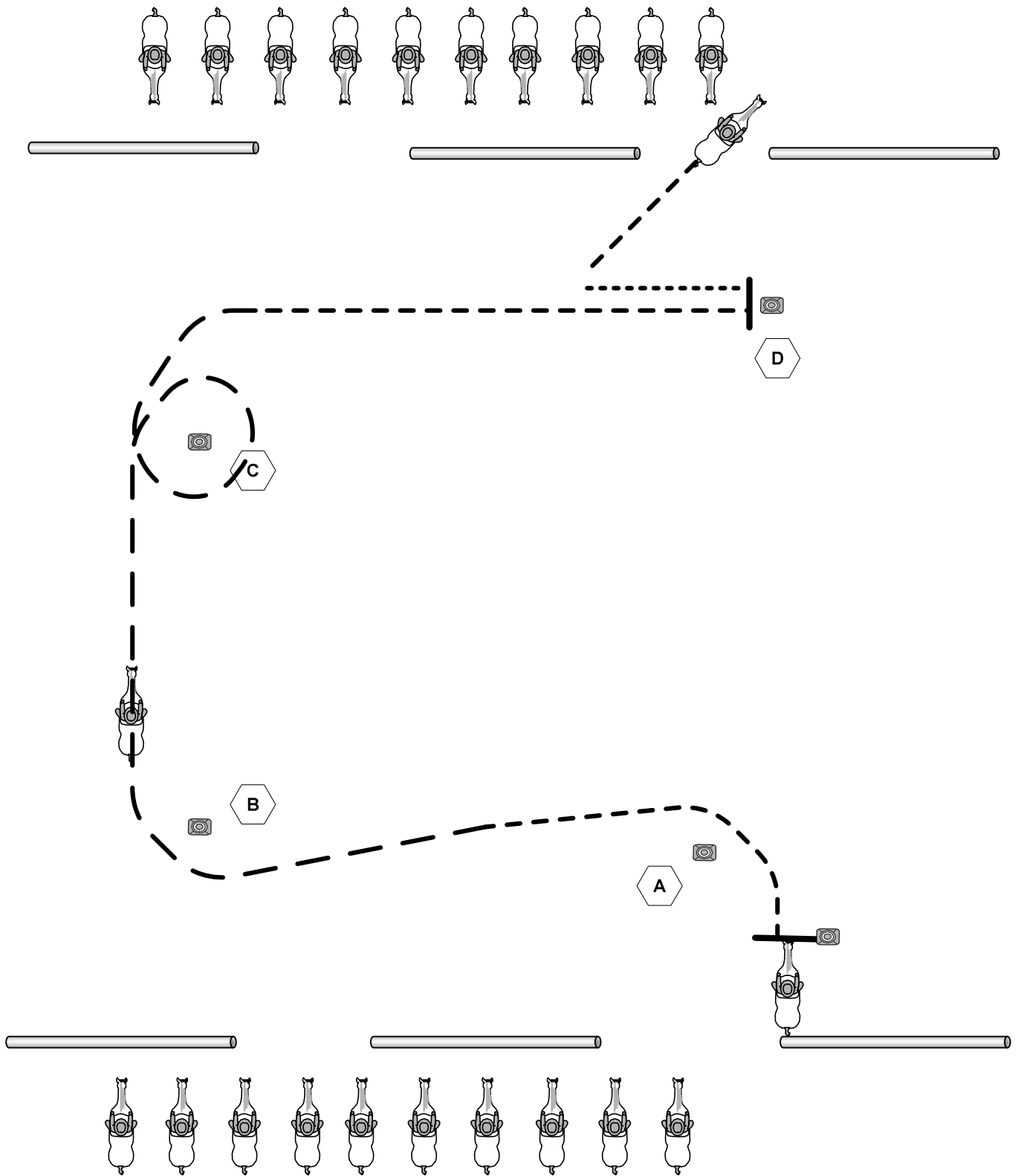

Alle Teilnehmer befinden sich im WarmUp-Bereich

- 1 Vom Start um A im Walk (Schritt)
 - 2 Zwischen A und B Übergang zum Jog (Trab)
 - 3 Jog um B bis C
 - 4 Kleine Volte im Jog um C
 - 5 Übergang zum Walk – Walk bis D
 - 6 Stop vor D – 5 Tritte Rückwärts richten – Ende der Aufgabe
- Im Walk zum WarmUp-Bereich hinter der Abgrenzung

Walk

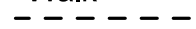

Jog

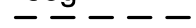

Lope

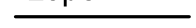

Back

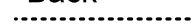

Reining Pattern 11 --- LK 1/2

Reining

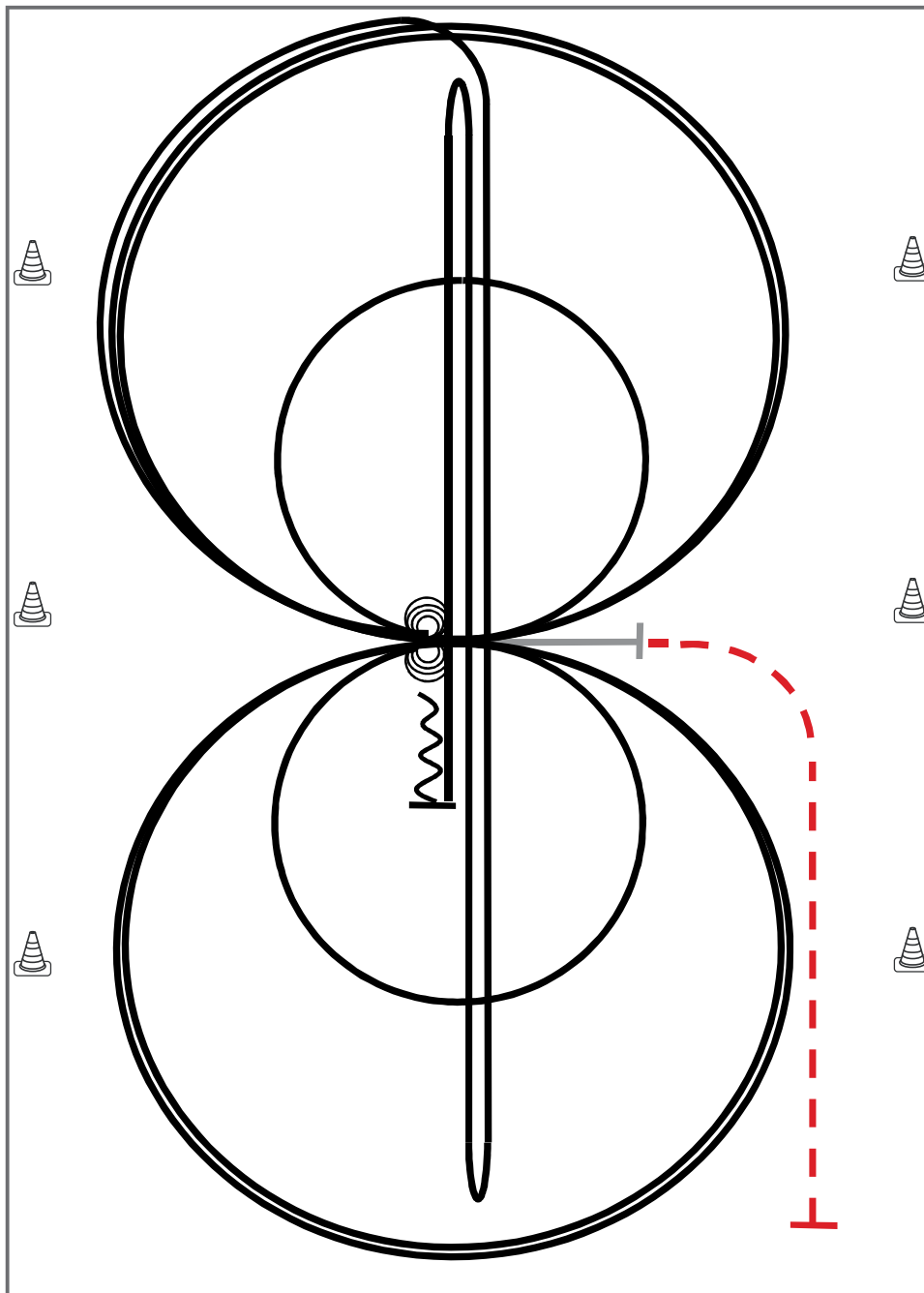

Im Trab zur Mitte der Bahn.
Beginn der Aufgabe aus dem Schritt oder aus dem Stand.

Trab	---
Galopp	—
Rückwärts	⋈⋈⋈

- 1) 4 Spins **links**, Verharren
- 2) 4 Spins **rechts**, Verharren
- 3) 3 Zirkel Galopp (**rechts**), **1. klein** und langsam, 2. + 3. groß und schnell, Galoppwechsel bei X
- 4) 3 Zirkel Galopp (**links**), **1. klein** und langsam, 2. + 3. groß und schnell, Galoppwechsel bei X
- 5) Galopp (**rechts**) auf dem Zirkel, der nicht geschlossen wird, Run Down auf der Mittellinie, Sliding Stop hinter dem **Endmarker**, Rollback **rechts**, kein Verharren
- 6) Run Down auf der Mittellinie, Sliding Stop hinter dem **Endmarker**, Rollback **links**, kein Verharren
- 7) Run Down auf der Mittellinie, Sliding Stop hinter dem **Mittelmarker**, Rückwärtsrichten bis zur Mitte der Bahn oder mind. 3,00 m, Verharren

Der Reiter muss das Kopfstück zur Gebisskontrolle vor dem Richter abnehmen.

BOSALINO®

wood and leather crafts



Unsere Produkte lassen Ihren Fuhrpark strahlen.



igepa-chemie GmbH
Mitterfeldstraße 7a | 93077 Bad Abbach
Tel. +49 (0)9405 / 9525-0 | info@clean-truck.de



www.clean-truck.de



FOLGE UNS



Hier geht's zum CleanTruck-Shop



alex mundorff
western riding & country lifestyle

Western Horsemanship --- GREENHORSE

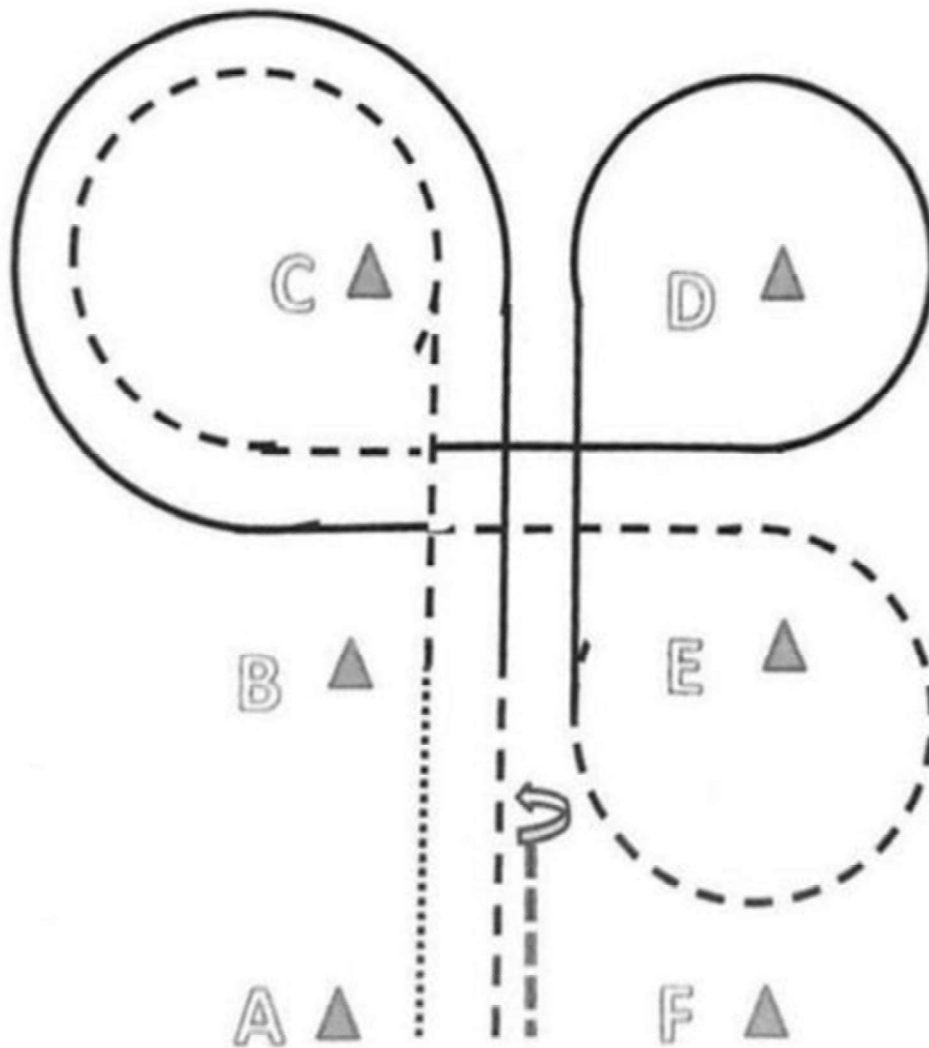

- 1) von A nach B Walk
von B nach C Jog, Jogvolte um C
- 2) zwischen B und C Lope links und weiter zu D
Lope Volte um D und weiter zu E
bei E Jog und Jogvolte um E und weiter bis zwischen B und C
- 3) bei C Lope rechts und Lope Volte um C
- 4) bei B Jog bis A, Stop, Back Up, 360°HHW links
- 5) im Walk in den Warm Up Bereich

EWU C Turnier Niedertaufkirchen

Walk Trot Horsemanship

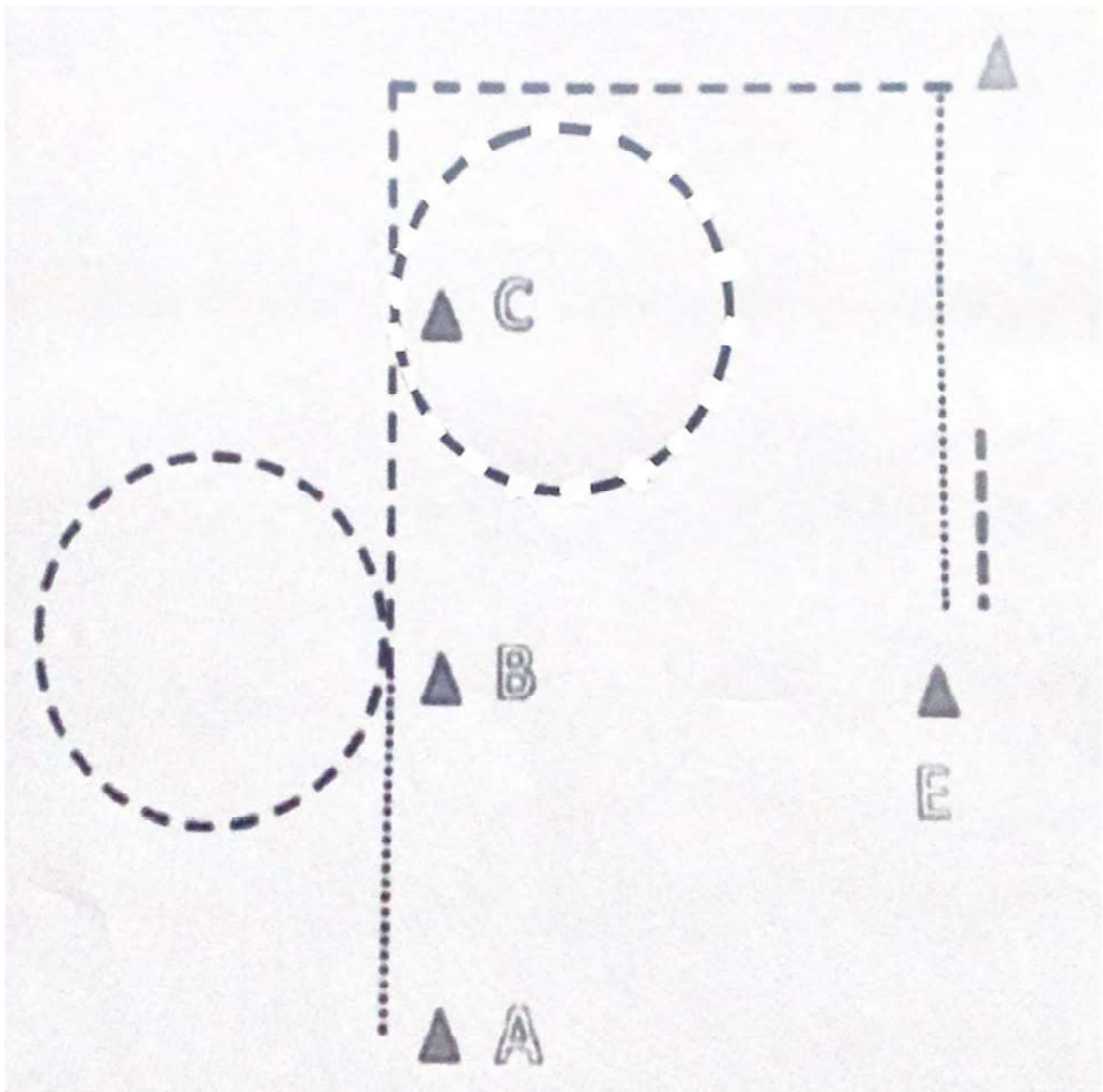

Von A nach B Walk

Jogvolte links bei B und weiter zu C

Jogvolte um C

Jog von C bis D

Walk von D nach E

Bei E anhalten und rückwärts richten

Western Horsemanship LK 5 *** LK 4B *** LK 4A

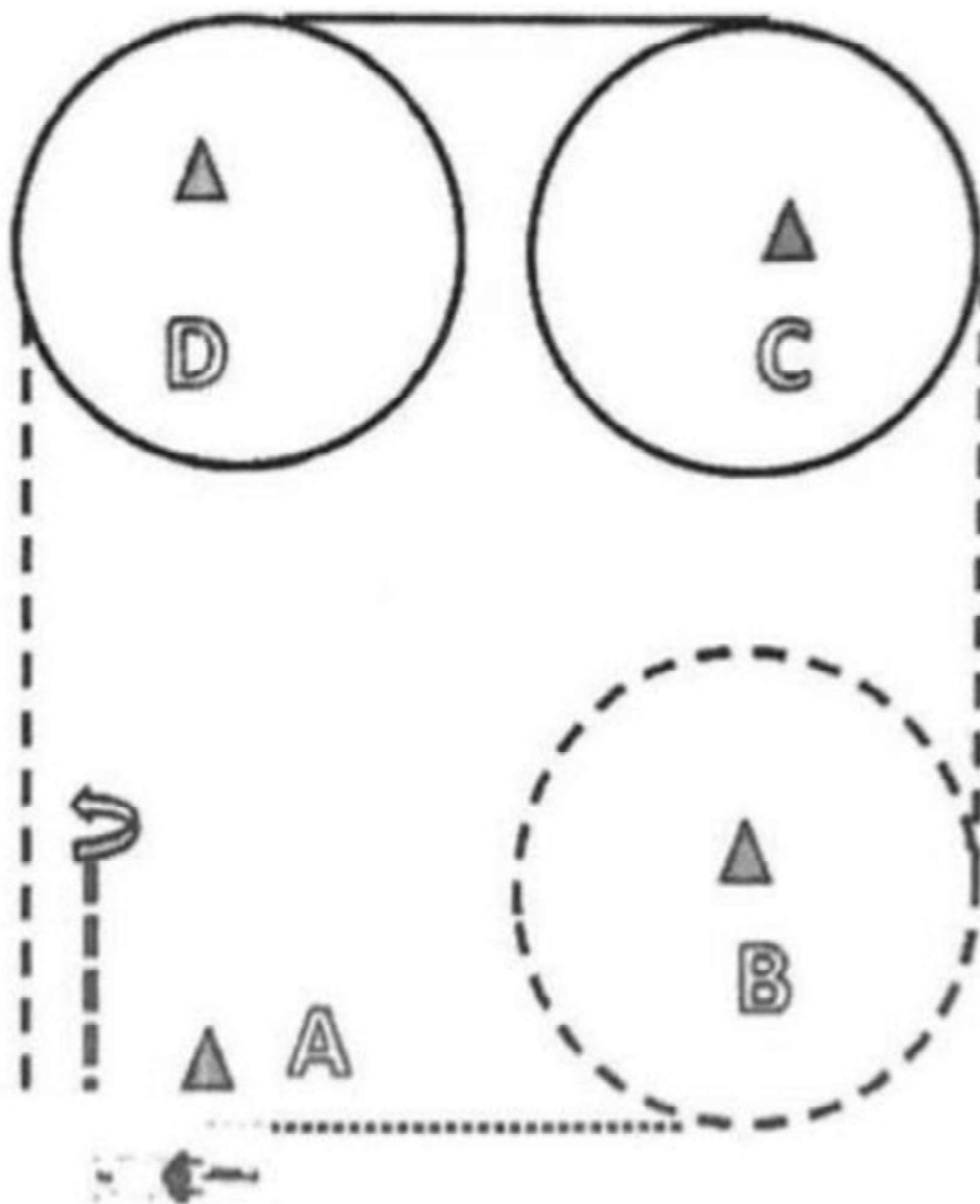

1. von A nach B Walk
Jogvolte um B und weiter bis C
2. Lopevolte um C und weiter zu D, Lopevolte um D
3. Jog zu A, bei A anhalten, rückwärtsrichten, 360 ° HHW links

Western Horsemanship LK 3 A --- LK 3 B

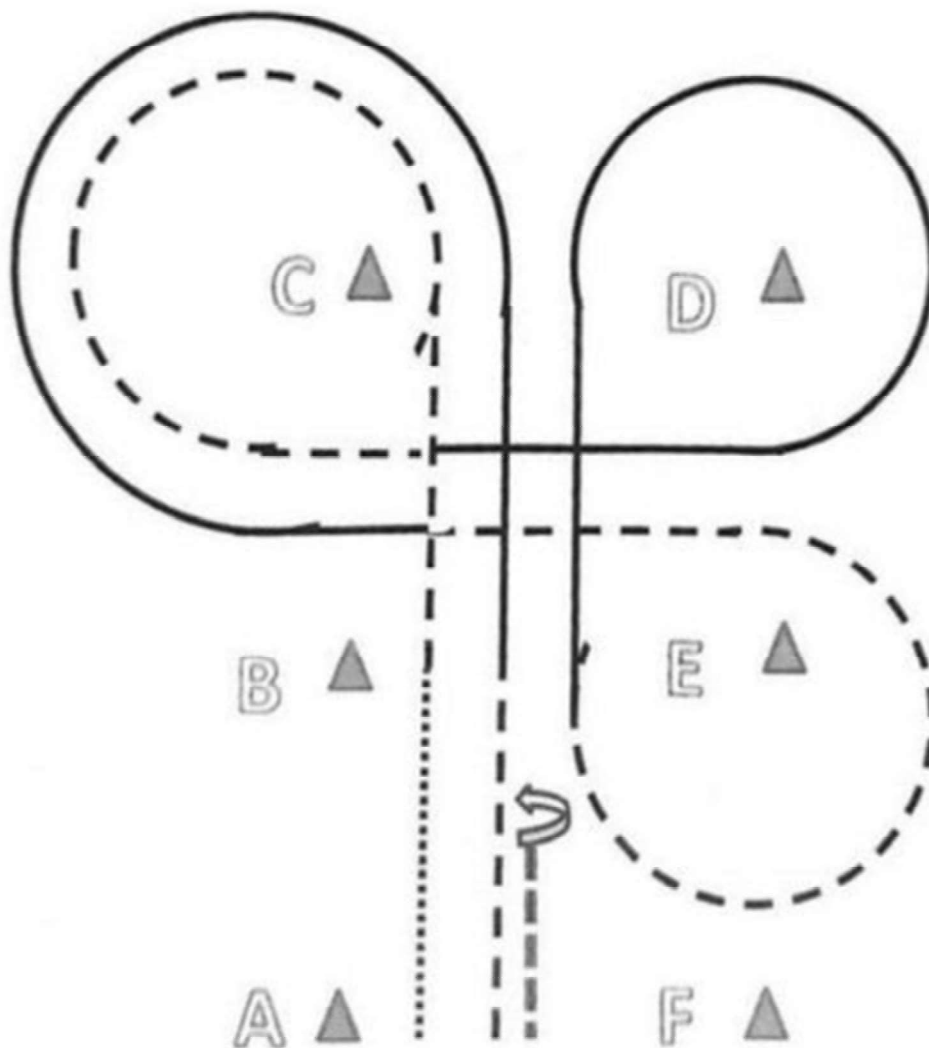

- 1) von A nach B Walk
von B nach C Jog, Jogvolte um C
- 2) zwischen B und C Lope links und weiter zu D
Lope Volte um D und weiter zu E
bei E Jog und Jogvolte um E und weiter bis zwischen B und C
- 3) bei C Lope rechts und Lope Volte um C
- 4) bei B Jog bis A, Stop, Back Up, 360°HHW links
- 5) im Walk in den Warm Up Bereich

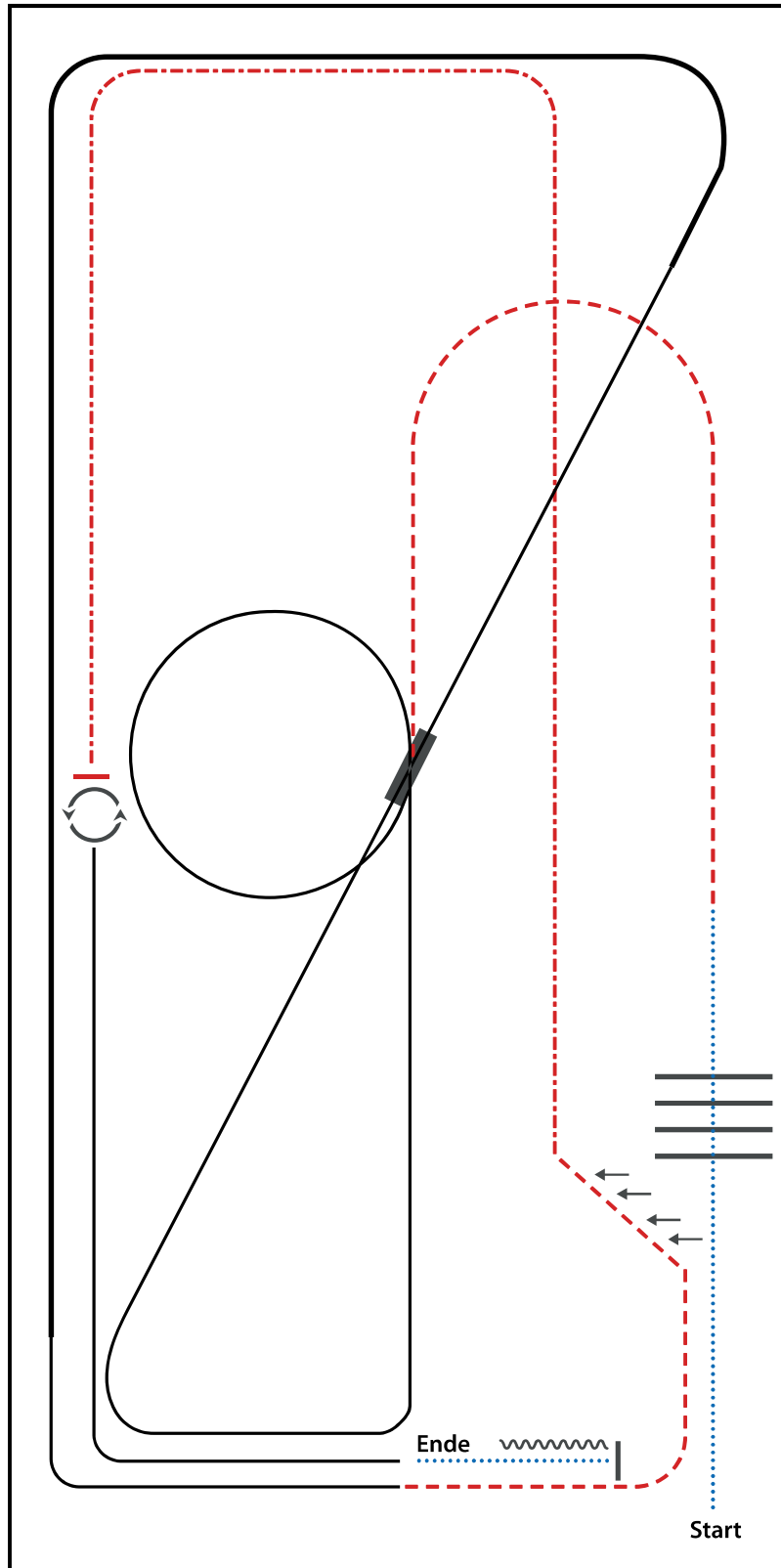

- 1) WALK
- 2) WALK OVER
- 3) TROT
- 4) LOPE (RL) SMALL CIRCLE, LOPE (RL)
- 5) CHANGE LEADS (SIMPLE OR FLYING)
- 6) LOPE (LL)
- 7) EXTENDED LOPE (LL), LOPE (LL)
- 8) TROT, TROT TWO TRACK LEFT
- 9) EXTENDED TROT
- 10) STOP, 360° TURNS (EACH DIRECTION)
- 11) LOPE (LL)
- 12) WALK, STOP, BACK UP

WALK (SCHRITT)	
EXTENDED WALK	
JOG/TROT (TRAB)	
EXTENDED TROT	
LOPE (GALOPP)	
EXTENDED LOPE	
BACK UP (RÜCKWÄRTS)	
LEAD CHANGE (GALOPPWECHSEL)	
TURN (DREHUNG)	

ERSTE WESTERNREITER UNION FÜR DEN VERBAND WESTERNREITER



Unsere Hauptsponsoren



AM TRATHL 17 + 93142 MAXHUTTE-PIRKENSEE
FACEBOOK.COM/DEINWESTERNSHOP
WWW.EDITION-WESTERN-SHOP.DE



Danke für die Unterstützung!

EWU-BAYERN.EV
www.ewu-bayern.de

Ranch Riding Walk Trot

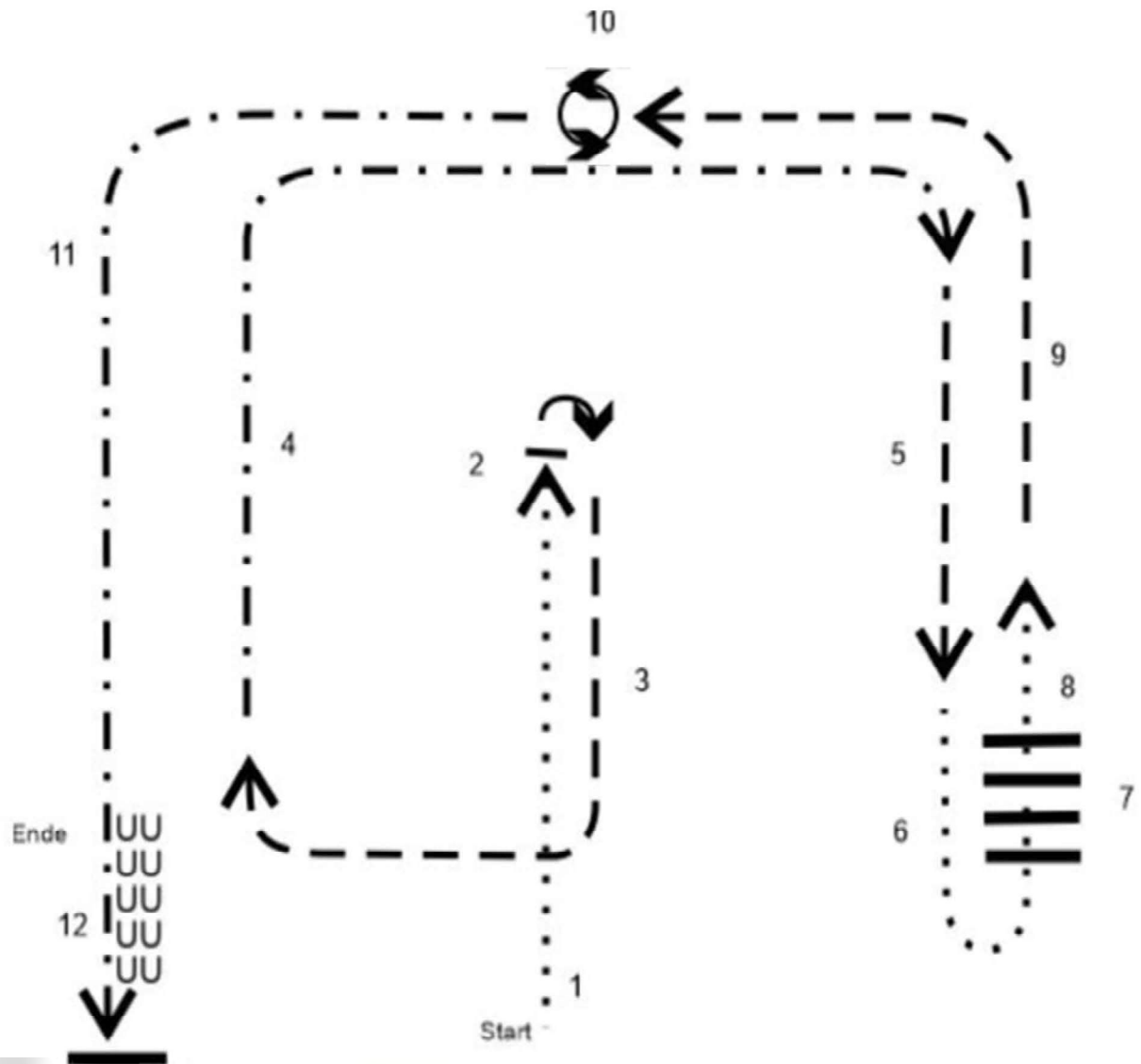

1. Schritt
2. Stop, 180° Hinterhandwendung rechts
3. Trab
4. verstärkter Trab
5. Trab
6. Schritt
7. Schritt über Stangen
8. Schritt
9. Trab
10. Stop, 360° Hinterhandwendung links
11. verstärkter Trab
12. Stop, Rückwärtsrichten

Handmade Saddles & Tack



Inhaber: Josef Fuchs
Werkstattleiter & Sattelpauer:
Manfred Aimer

Sherwood Ranch Saddlery

D-84494 Niedertaufkirchen
Hinteralbing 1

Mobil: +49 (0) 172 / 8 13 97 39
Telefon: +49 (0) 86 35 / 69 38 59

eMail: Info@sherwoodranch.de

DIREKT AUF DER SHERWOODRANCH IN NIEDERTAUFKIRCHEN

Teilnehmer EWU C-Turnier II/24 Niedertaufkirchen

Start	Reiter	LK	LV	Pferd	Rasse
1	Katharina Vogel	LK 2A	BAY	RH Stormkitty Solano	QH
	LK 1/2 RN ,LK 1/2 WHS ,LK 2 RR ,SO Getränke WPL ,SO JP RR LK 1-5				
2	Katharina Vogel	LK 2A	BAY	TALISMANIC ROOSTER	QH
	LK 1/2 TH ,LK 1/2 WPL ,LK 1/2 WRR ,LK 2 RR				
3	Susanne Drasch	LK 3A	BAY	Who Is Berts Boo	QH
	LK 3 WPL ,LK 3 WRR ,LK 3A RR ,LK 3A TH ,SO Getränke WPL				
4	Eva Weigl	LK 2A	BAY	Zippo's Special Kay LK	PIN
	1-3 SSH ,LK 1/2 WHS ,LK 1/2 WPL ,LK 1/2 WRR ,LK 2 RR ,SO Getränke WPL				
5	Judith Holzer	LK 3A	BAY	Ima Bay Cocktail	QH
	LK 3A RR ,LK 3A TH ,LK 3A WHS				
6	Manuela Geier	LK 2A	BAY	WB Smokin Serenade	QH
	LK 1/2 RN ,LK 1/2 TH ,LK 1/2 WHS ,LK 1/2 WPL ,LK 1/2 WRR ,LK 2 RR ,SO Getränke WPL ,SO GH TH				
7	Antonia Hoose	LK 2B	BAY	Lillians Mystical Wonder	QP
	LK 1/2 TH ,LK 1/2 WHS ,LK 1/2 WPL ,LK 1/2 WRR ,LK 2 RR ,SO Getränke WPL ,SO JP RR LK 1-5				
8	Liara Ziegler	LK 5B		Lillians Mystical Wonder	QP
	SO SO FZ				
9	Christina Langer	LK 2A	BAY	Whoolahoop	QH
	LK 1/2 RN ,LK 1/2 TH ,LK 1/2 WHS ,LK 1/2 WRR ,LK 2 RR ,SO JP RR LK 1-5				
10	Theresa Ludwig	LK 3B	BAY	A Redbull	QH
	LK 3B RR ,LK 3B TH ,LK 3B WHS				
11	Alexandra Ludwig	LK 4A	BAY	Whoomer	QH
	LK 4/5 A TH ,LK 4A RR ,LK 4A WHS				
12	Theresa Ludwig	LK 3B	BAY	Whoomer	QH
	LK 3B RR ,LK 3B TH				
13	Sabrina Kastner	LK 3A	BAY	Whiztopep	QH
	LK 3 RN ,LK 3 WPL ,LK 3 WRR ,LK 3A RR ,LK 3A TH ,LK 3A WHS ,SO JP RR LK 1-5				
14	Angelika Sandbichler	LK 1A	BAY	What's Up	EHAL
	SO JP RR LK 1-5				
15	Christina Kirmeier	LK 3B	BAY	Sternbergs Make Me Happy	CON
	LK 3 RN ,LK 3 WRR ,LK 3B RR ,SO Getränke WPL ,SO JP RR LK 1-5				
16	Emelie Zeulner	LK 4B	BAY	Spotted Rocketman	APP
	LK 4B RN ,LK 4B RR ,LK 4B WPL ,LK 4B WRR ,SO Getränke WPL ,SO JP RR LK 1-5				
17	Rebecca Huber	LK 3A	BAY	Smokyguns Devilrose	QH/PH
	LK 3 WPL ,LK 3 WRR ,LK 3A RR ,LK 3A WHS ,SO JP RR LK 1-5				
18	Jasmin Dillitz	LK 4A	BAY	Tari Whizin Jack	QH
	LK 4/5 A TH ,LK 4A RN ,LK 4A RR ,LK 4A WHS ,LK 4A WRR ,SO JP RR LK 1-5				
19	Nadine Hartmann	LK 1A	BAY	TALISMANIC ROOSTER	QH
	SO Getränke WPL ,SO JP RR LK 1-5				
20	Lisa Mayer	LK 4A	BAY	Sayos Grab Shiner	QH
	LK 4A RN ,LK 4A RR				
21	Sophia Strein	LK 4A	BAY	Hollister Bobby	QH
	LK 4/5 A TH ,LK 4/5 SSH ,LK 4A RR ,LK 4A WHS ,LK 4A WRR				
22	Sybille Reiter	LK 4A	BAY	Queen Elisabeth	QH
	LK 4A RR ,LK 4A WPL ,LK 4A WRR ,SO JP RR LK 1-5				
23	Lena Linnerer	LK 4A	BAY	Justice Pay Gold	QH
	LK 4/5 A TH ,LK 4A RR ,LK 4A WHS ,LK 4A WRR				
24	Sophia Strein	LK 4A	BAY	Justice Pay Gold	QH
	LK 4A WPL				

25	Anna Klessinger	LK 2B	BAY	Sliding King O Lena	PH
	LK 1/2 RN ,LK 1/2 WRR ,LK 2 RR ,SO JP RR LK 1-5				
26	Anna Klessinger	LK 2B	BAY	Magnum Gunlight	QH
	LK 1/2 WHS ,LK 2 RR ,SO JP RR LK 1-5				
27	Verena Klessinger	LK 4A	BAY	Magnum Gunlight	QH
	LK 4A RR ,LK 4A WHS ,LK 4A WPL ,SO GH WHS				
28	Verena Klessinger	LK 4A	BAY	Sliding King O Lena	PH
	LK 4A RN ,LK 4A RR ,LK 4A WRR				
29	Michaela Hohenauer	LK 3A	BAY	Black Prince Lesharo	APP
	LK 3 RN ,LK 3 WRR ,LK 3A RR ,SO Getränke WPL				
30	Emma Kainzlsperger	LK 5B		Tippi	PH
	WT RR ,WT TH ,WT WHS B ,WT WPL				
31	Swenja Kopplin	LK 3A	BAY	Brain	Hal
	LK 3A TH ,LK 3A WHS ,SO GH WHS ,SO JP RR LK 1-5				
32	Katrin Mayerhofer	LK 4A	BAY	Poco King Dun It	QH
	LK 4/5 A TH ,LK 4/5 SSH ,LK 4A RR ,LK 4A WHS ,LK 4A WPL ,LK 4A WRR				
33	Maya Wagner	LK 3A	BAY	Nurini	EHAL
	LK 1-3 SSH ,LK 3 WPL ,LK 3 WRR ,LK 3A RR ,LK 3A TH ,LK 3A WHS				
34	Johanna Koch	LK 1A	BAY	Smart One Shot	QH
	LK 1 RR ,LK 1-3 SSH ,LK 1/2 TH ,LK 1/2 WHS ,LK 1/2 WPL				
35	Nadine Schiemer	LK 4A	BAY	KBW Black Vario King	QH
	LK 4/5 A TH ,LK 4A RN ,LK 4A RR ,LK 4A WHS ,LK 4A WPL ,LK 4A WRR				
36	Marion Seehuber	LK 4A	BAY	Mirabelle 64	WFL
	LK 4/5 A TH				
37	Magdalena Seehuber	LK 5B		Mirabelle 64	WFL
	SO SO FZ				
38	Silke Oberle	LK 4A	BAY	Peaches Soul Melody	WGP
	LK 4A WHS ,LK 4A WPL ,LK 4A WRR				
39	Bianca Wandinger	LK 4A	BAY	My Colonel Gunlight	QH
	LK 4/5 A TH ,LK 4A RR ,LK 4A WHS ,LK 4A WPL ,LK 4A WRR ,SO JP RR LK 1-5				
40	Alexandra Pilger	LK 4A	BAY	Granada	AN
	LK 4/5 A TH ,LK 4A RR ,LK 4A WHS ,LK 4A WPL ,LK 4A WRR				
41	Nicole Stahff	LK 4A	BAY	DIAMONDSMASTERTRIP	QH
	LK 4/5 SSH ,WT RR ,WT TH ,WT WHS A				
42	Isabella Meister	LK 5B	BAY	TD Captain Amerika	QH
	LK 4/5 SSH ,WT RR ,WT TH ,WT WHS B ,WT WPL				
43	Leonie Meister	LK 4B	BAY	TD Captain Amerika	QH
	LK 4/5 B TH ,LK 4B RN ,LK 4B RR ,LK 4B WHS ,LK 4B WPL ,LK 4B WRR ,SO Getränke WPL				
44	Emily Gerzer	LK 5B		Golden Legacy Dun It	QH
	WT RR ,WT WHS B				
45	Marlene Sager	LK 5A		Lillians Mystical Wonder	QP
	WT WPL				
46	Flora Nitz	LK 5B		UT Jinges Cherita	PH
	LK 4/5 B TH ,LK 5 WHS ,LK 5 WPL				
47	Sara Witalinski	LK 5B		Blue Power	QH
	LK 4/5 SSH ,LK 5 WHS ,LK 5 WPL				
48	Lina Pfaffinger	LK 2A	BAY	JS Poco Blue Jac Dun	APP
	LK 1/2 RN ,LK 1/2 WHS ,LK 1/2 WPL ,LK 1/2 WRR ,SO Getränke WPL ,SO JP RR LK 1-5				
49	Franziska Niedermayr	LK 1A	BAY	Blue Power	QH
	SO GH WPL				
50	Manuela Niedermayr	LK 3A	BAY	Katys Blazin Nite	PH

	LK 3 WPL ,LK 3A TH ,LK 3A WHS				
51	Manuela Niedermayr LK 1-3 SSH	LK 3A	BAY	Blue Power	QH
52	Susanne Singer LK 4A RR ,LK 4A WRR	LK 4A	BAY	Wimpys Forrest Gump	QH
53	Luca Witalinski WT WHS B ,WT WPL	LK 5B		UT Jinges Cherita	PH
54	Linda Nitz WT RR ,WT TH	LK 5B		UT Jinges Cherita	PH
55	Diana Sterzer LK 1/2 WPL ,LK 1/2 WRR ,LK 2 RR ,SO Getränke WPL ,SO JP RR LK 1-5	LK 2A	BAY	JP Morocco Whiz	QH
56	Selina Dexl LK 1-3 SSH ,LK 3 WPL ,LK 3B WHS	LK 3B	BAY	TNT Peppys Best	PH
57	Verena Kornes LK 3 WRR ,LK 3A RR ,LK 3A TH	LK 3A	BAY	TNT Peppys Best	PH
58	Andreas Walter Johann Böck LK 4A RR ,LK 4A WRR ,SO GH RR	LK 4A	BAY	Mr Bevs Cooper	QH
59	Alexandra Zielke WT TH ,WT WHS A	LK 5A		Abby	WGP
60	Pia Rehberger LK 4/5 B TH ,LK 4B WHS ,LK 4B WPL ,LK 4B WRR	LK 4B	BAY	Who Is Berts Boo	QH
61	Angelina Herzig-Gumminger LK 4/5 A TH ,LK 5 RR ,LK 5 WHS ,LK 5 WPL ,SO LK 5 WRR	LK 5A		SR Tivio DOC Domino	QP
62	Josephine Krapf LK 4/5 B TH ,LK 5 RR ,LK 5 WHS	LK 5B		Dun it Bella Queen	QH
63	Magdalena Maschberger LK 4B RN ,LK 4B RR ,LK 4B WHS ,LK 4B WRR ,SO JP RR LK 1-5	LK 4B	BAY	Rumble Bop	QH
64	Annamaria Weimar LK 1-3 SSH ,LK 1/2 TH ,LK 1/2 WHS ,LK 1/2 WPL ,LK 2 RR ,SO Getränke WPL ,SO JP RR LK 1-5	LK 2A	BAY	Hollywoodsinvitation	QH
65	Lisa Klinger LK 5 RR ,LK 5 WHS ,LK 5 WPL	LK 5A		Isabell	APPM
66	Christine Haas LK 3 WRR ,LK 3A RR ,LK 3A TH ,LK 3A WHS ,SO Getränke WPL ,SO JP RR LK 1-5	LK 3A	BAY	Rio	APPM
67	Claudia Anetseder LK 4/5 A TH ,LK 4A RR ,LK 4A WHS ,LK 4A WRR ,SO Getränke WPL	LK 4A	BAY	PS Ruf Lil Alice	APP
68	Barbara Jelinek LK 4/5 A TH ,LK 4/5 SSH ,LK 4A RR ,LK 4A WHS ,LK 4A WPL ,LK 4A WRR	LK 4A	BAY	Happy	SD-K
69	Theresa Holler LK 1/2 TH ,LK 1/2 WHS ,LK 1/2 WRR ,LK 2 RR ,SO Getränke WPL ,SO JP RR LK 1-5	LK 2A	BAY	Dudes Black Diego	QH
70	Emma Neumann LK 4/5 B TH ,LK 4/5 SSH ,LK 4B RR ,LK 4B WHS ,LK 4B WPL ,LK 4B WRR ,SO JP RR LK 1-5	LK 4B	BAY	CatstonesKimiMisaeZip	PH
71	Isabel Löschner LK 1 RR ,LK 1/2 TH ,LK 1/2 WHS ,SO Getränke WPL ,SO GH WHS ,SO JP RR LK 1-5	LK 1A	BAY	CS Elites Just Fun	QH
72	Pia Schuster LK 3 WPL ,LK 3 WRR ,LK 3A TH ,LK 3A WHS	LK 3A	BAY	Peppy Sally Freckles	QH
73	Lena Hetzner LK 1/2 TH ,LK 1/2 WHS ,LK 1/2 WPL ,SO Getränke WPL	LK 2A	BAY	Wild Tec Jac	QH
74	Sophia Ascherl LK 4/5 B TH ,LK 4/5 SSH ,LK 4B WHS ,SO GH TH	LK 4B	BAY	Brioni Boon	QH
75	Katharina Ascherl LK 4/5 B TH ,LK 4/5 SSH ,LK 5 WHS ,SO GH TH	LK 5B		Keepme Loveme Kruzme	QH

76	Ulrike Stowasser LK 4A RR ,LK 4A WRR	LK 4A	BAY	Sir Henry Buck	QH
77	Franziska Pledl LK 4/5 SSH ,WT RR ,WT WHS A	LK 5A		BHK BUBBASLILPRINCESS	QH
78	Lena Auberger LK 4/5 A TH ,LK 4/5 SSH ,LK 4A RR ,LK 4A WHS ,LK 4A WPL	LK 4A	BAY	RJ Heaven Mr Zip	PH
79	Anna Willmann LK 1/2 WPL ,SO GH TH ,SO GH WHS ,SO GH WPL	LK 2A	BAY	RJ Heaven Mr Zip	PH
80	Ulrike Wehner LK 3 RN ,LK 3 WRR ,LK 3A RR ,LK 3A TH ,LK 3A WHS	LK 3A	BAY	Double Jac Cody	PH
81	Laura Haas WT RR ,WT TH	LK 5B		Double Oak Glorie	QH
82	Sophie Haas WT WHS B ,WT WPL	LK 5B		Double Oak Glorie	QH
83	Josephine Haas SO SO FZ	LK 5B		Double Oak Glorie	QH
84	Laetitia Eckmann LK 3 WPL ,LK 3 WRR ,LK 3A RR ,LK 3A TH ,LK 3A WHS ,SO Getränke WPL	LK 3A	BAY	Zahims Zahira	ArbVB
85	Lisa Karl LK 3A RR ,SO GH RR	LK 3A	BAY	Royal Spotted Gun	QH
86	Katharina-Sophia Gschwendtner LK 4/5 B TH ,LK 4B RN ,LK 4B RR ,LK 4B WHS ,LK 4B WPL ,LK 4B WRR	LK 4B	BAY	LR Slide With Saints	QH
87	Anna Knoll LK 4/5 B TH ,LK 5 RR ,LK 5 WHS ,SO LK 5 WRR	LK 5B		Epitome Marry Ann	QH
88	Tanja Freund LK 1 RR ,SO GH RR	LK 1A	BAY	My Colonel Gunlight	QH
89	Kathrin Sedlmeier LK 1/2 RN ,LK 1/2 WHS ,LK 1/2 WRR ,LK 2 RR ,SO JP RR LK 1-5	LK 2A	BAY	Mega Scotch Rocker	QH
90	Johanna Schreindl LK 4/5 B TH ,LK 5 RR ,LK 5 WHS	LK 5B		CEE WALLA WHIZ BEE	QH
91	Emilia Brenninger LK 5 RR ,LK 5 WHS	LK 5B		Magnum Gunlight	QH
92	Lena Buttenberg LK 4B WHS ,LK 4B WPL	LK 4B	BAY	Hollister Bobby	QH
93	Selina Zoe Kölbl WT RR ,WT WHS A ,WT WPL	LK 4A	BAY	Flashes Magic Snowman	QH
94	Christine Gutmüthl LK 4A RR ,LK 4A WRR ,SO Getränke WPL	LK 4A	BAY	CEE WALLA WHIZ BEE	QH
95	Lea Sophie Schreindl SO SO FZ	LK 5B		CEE WALLA WHIZ BEE	QH
96	Gina Sophia Allinger LK 1/2 RN ,LK 1/2 TH ,LK 1/2 WHS ,LK 1/2 WPL ,LK 2 RR ,SO Getränke WPL	LK 2A	BAY	AJ Smart Cowboy	QH
97	Romy Stannecker LK 3 WPL ,LK 3 WRR ,LK 3B RR ,LK 3B TH ,LK 3B WHS ,SO Getränke WPL	LK 3B	BAY	What's Up	EHAL
98	Manuela Hiersche LK 4A WRR	LK 4A	BAY	CFR Charlie Lion	QH
99	Carina Schubert LK 3 WPL ,LK 3 WRR ,LK 3A RR ,SO GH RR ,SO GH WPL	LK 3A	BAY	AbileneBlueSmartSujo	PH
100	Samuel Fuchs SO SO FZ	LK 5B	BAY	Spat Dry Lena	QH
101	Josef Fuchs	LK 2A	BAY	Cash Commander	QH

LK 1/2 TH ,LK 1/2 WPL ,LK 1/2 WRR ,LK 2 RR ,SO Getränke WPL

102	Johanna Fuchs LK 3A RR ,LK 3A TH ,LK 3A WHS	LK 3A	BAY	Spat Dry Lena	QH
103	Josef Fuchs LK 1/2 RN	LK 2A	BAY	Spat Dry Lena	QH
104	Emma Häusler SO SO FZ	LK 5B	BAY	Sweet Lil Flicka	QH
105	Sophia Hanis SO SO FZ	LK 5A		Whooper	QH
106	Luna Schnitzler LK 1/2 TH ,LK 1/2 WHS ,LK 1/2 WRR ,LK 2 RR ,SO GH RR ,SO JP RR LK 1-5	LK 2B	BAY	Smart as you	QH
107	Regina Buttman LK 3 WRR ,LK 3A RR ,LK 3A TH ,LK 3A WHS	LK 3A	BAY	Choco Dream Edition	QH
108	Stephanie Wortmann LK 4/5 A TH	LK 5A		Chayenne 190	PIN
109	Christina-Marie Egerer LK 3 WRR ,LK 3A RR ,SO GH RR ,SO GH WPL	LK 3A	BAY	Flame Of Wimpy	QH
110	Leonie Christoph LK 5 WPL	LK 5B		Flame Of Wimpy	QH
111	Leonie Christoph WT TH ,WT WHS B	LK 5B		Baccara	Hal
112	Maren Schmid SO SO FZ	LK 5B		Chayenne 190	PIN
113	Anna Achhammer WT WPL	LK 5B		Flame Of Wimpy	QH
114	Elias Schmid WT WHS B	LK 5B		Chayenne 190	PIN
115	Anna Achhammer LK 4/5 SSH	LK 5B		Baccara	Hal
116	Elisa Hausmann LK 4B RR ,SO GH RR	LK 4B	BAY	Summer Edition	PH
117	Emilia Blösch LK 3 WPL ,LK 3 WRR ,LK 3B RR ,LK 3B TH ,LK 3B WHS ,SO Getränke WPL ,SO GH TH	LK 3B	BAY	Highclass Winchester	QH
118	Christine Blasi LK 1 RR ,LK 1/2 RN ,LK 1/2 TH ,LK 1/2 WPL ,SO Getränke WPL	LK 1A	BAY	BMS Chilly Special	QH
119	Emilia Blösch LK 3 RN	LK 3B	BAY	BMS Chilly Special	QH
120	Stefanie Meinzinger LK 4A RR ,LK 4A WPL ,LK 4A WRR	LK 4A	BAY	Bandit	TI
121	Traudl Drechsler LK 3A TH ,LK 3A WHS	LK 3A	BAY	JQ Miss Jacky D	PH
122	Doris Voichtleitner LK 3A TH ,LK 3A WHS	LK 3A	BAY	Sóley Surprise	QP
123	Emily Sterzer LK 5 RR ,SO LK 5 WRR	LK 5B		JP Morocco Whiz	QH
124	Jana Simon LK 1-3 SSH ,LK 3 WPL ,LK 3A RR ,LK 3A WHS	LK 3A	BAY	Elta Crome	QH
125	Elena Putz LK 4/5 A TH ,LK 5 RR ,LK 5 WHS ,SO LK 5 WRR	LK 5A		Fancy needs no gun	QH
126	Lisa Prager LK 1/2 WRR ,LK 2 RR ,SO JP RR LK 1-5	LK 2A	BAY	SH Texchex Leo	QH

127	Janina Löschner LK 3 WPL	LK 3A	BAY	Glory Diamonds Rock	QH
128	Tobias Gudmundsson SO SO FZ	LK 5B		Mega Scotch Rocker	QH
129	Noah Leippert SO SO FZ	LK 5B		Bill	IC
130	Ella Leippert SO SO FZ	LK 5B		George	PIN
131	Hailey Leippert WT WHS B	LK 5B		Bill	IC

Beim



Turnier



vor Ort





Pferdepension ~ Guest-Ranch

Josef Fuchs
Pferdewirtschaftsmeister



~ Pferdepension ~

Alle Haltungsformen - Westernreitunterricht - Beritt
Wanderreitstation - Urlaubsranch mit und ohne Pferd



Hinteralbing 1

84494 Niedertaufkirchen

Mobil: +49.(0)172.8139739

Tel.: +49.(0)8635.693860

Fax: +49.(0)8635.693859

eMail: info@sherwoodranch.de

www.sherwoodranch.de

