

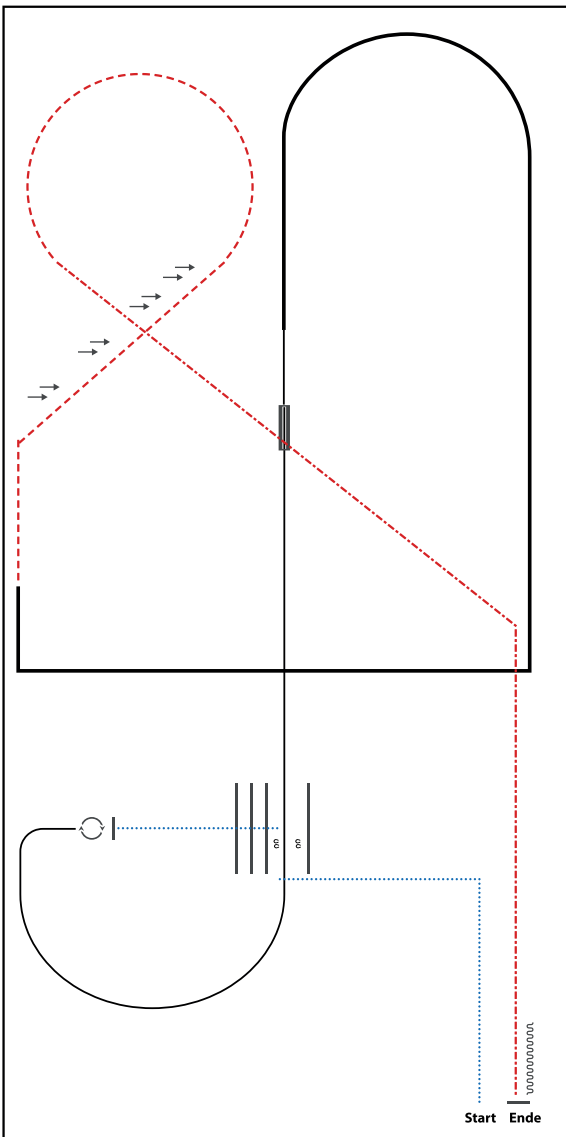

Ranch Riding Pattern 1 - 39

Inhaltsverzeichnis # 1- 38	Seite 2
# 1 RR Q M sen. LK 1/2	Seite 3
# 2 RR Q M sen. LK 1/2	Seite 4
# 3 RR Q M sen. LK 1/2	Seite 5
# 4 RR Q M sen. LK 1/2	Seite 6
# 5 RR Q M sen. LK 1/2	Seite 7
# 6 RR Q M sen. LK 1/2	Seite 8
# 7 RR Q M sen. LK 1/2	Seite 9
# 8 RR Q M sen. LK 1/2	Seite 10
# 9 RR Q M sen. LK 1/2	Seite 11
#10 RR Q M sen. LK 1/2	Seite 12
#11 RR Q M sen. LK 1/2	Seite 13
#12 RR Q M sen. LK 1/2	Seite 14
#13 RR Q M sen. LK 1/2	Seite 15
#14 RR Q M sen. LK 1/2	Seite 16
#15 RR Q M sen. LK 1/2	Seite 17
#16 RR Q M sen. LK 1/2	Seite 18
#17 RR Q M jun. LK 1/2	Seite 19
#18 RR Q M jun. LK 1/2	Seite 20
#19 RR Q M jun. LK 1/2	Seite 21
#20 RR Q M jun. LK 1/2	Seite 22
#21 RR Q M jun. LK 1/2	Seite 23
#22 RR Q M jun. LK 1/2	Seite 24
#23 RR Q M jun. LK 1/2	Seite 25
#24 RR Q M jun. LK 1/2	Seite 26
#25 RR Q M jun. LK 1/2	Seite 27
#26 RR Q M jun. LK 1/2 und LK 3	Seite 28
#27 RR Q M jun. LK 1/2 und LK 3	Seite 29
#28 RR LK 1-3	Seite 30
#29 RR LK 1-3	Seite 31
#30 RR LK 4/5	Seite 32
#31 RR LK 4/5	Seite 33
#32 RR LK 4/5	Seite 34
#33 RR LK 4/5	Seite 35
#34 RR LK 4/5	Seite 36
#35 RR LK 4/5	Seite 37
#36 RR LK 4/5	Seite 38
#37 RR LK 4/5	Seite 39
#38 RR LK 4/5	Seite 40
#39 RR LK 4/5	Seite 41



- 1) WALK CORNER
- 2) SIDEPASS RIGHT, WALK OVER
- 3) STOP, 360° TURNS (EACH DIRECTION)
- 4) LOPE (LL)
- 5) LEADCHANGE (SIMPLE OR FLYING), LOPE (RL)
- 6) EXTENDED LOPE (RL)
- 7) EXTENDED LOPE CORNERS
- 8) TROT, TWO TRACK RIGHT
- 9) TROT
- 10) EXTENDED TROT
- 11) STOP, BACK UP

WALK (SCHRITT)	
EXTENDED WALK	
JOG/TROT (TRAB)	
EXTENDED TROT	
LOPE (GALOPP)	
EXTENDED LOPE	
BACK UP (RÜCKWÄRTS)	
LEAD CHANGE (GALOPPWECHSEL)	
TURN (DREHUNG)	
	ERSTE
	WESTENREITER
	UNION
	PROBENGEFÜHRTE WESTENREITER

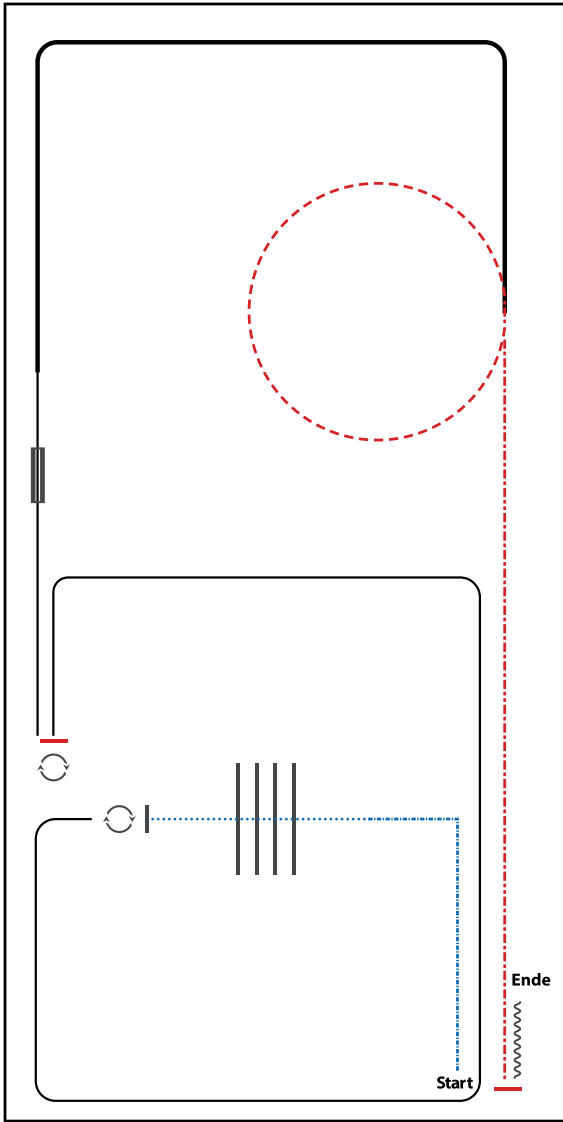

- 1) EXTENDED WALK CORNER
- 2) WALK OVER, WALK
- 3) STOP, 360° TURN LEFT
- 4) LOPE (LL)
- 5) STOP, 180° TURN RIGHT
- 6) LOPE (LL), LEADCHANGE (SIMPLE OR FLYING)
- 7) LOPE (RL), EXTENDED LOPE (RL)
- 8) TROT, SMALL CIRCLE
- 9) EXTENDED TROT
- 10) STOP, BACK UP

WALK (SCHRITT)	
EXTENDED WALK	
JOG/TROT (TRAB)	
EXTENDED TROT	
LOPE (GALOPP)	
EXTENDED LOPE	
BACK UP (RÜCKWÄRTS)	
LEAD CHANGE (GALOPPWECHSEL)	
TURN (DREHUNG)	
ERSTE	
WESTENREITER	
UNION	
WESTENREITER	

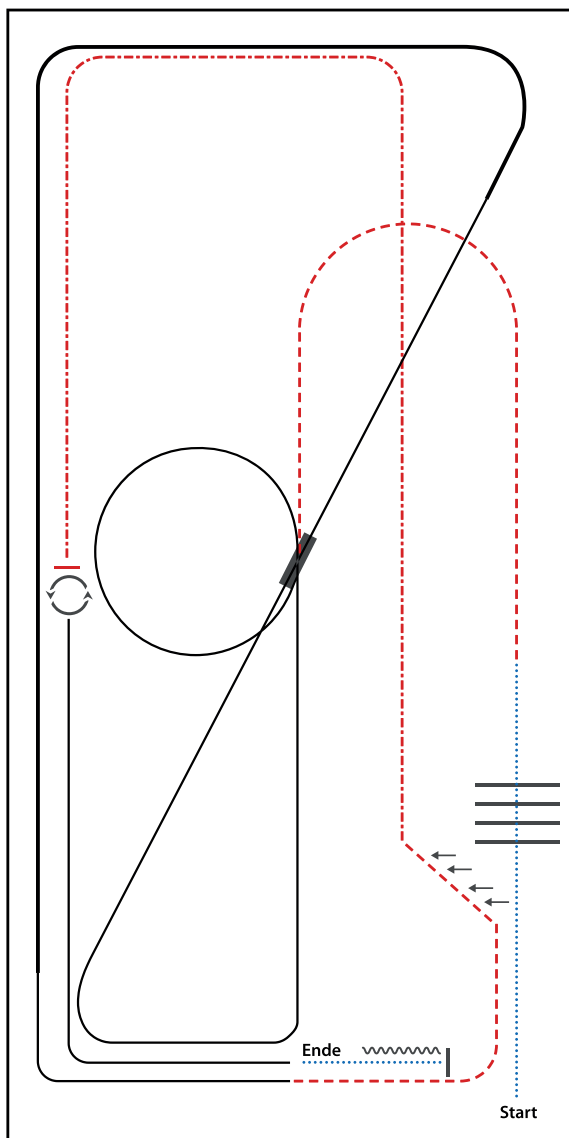

- 1) WALK
- 2) WALK OVER
- 3) TROT
- 4) LOPE (RL) SMALL CIRCLE, LOPE (RL)
- 5) LEADCHANGE (SIMPLE OR FLYING)
- 6) LOPE (LL)
- 7) EXTENDED LOPE (LL), LOPE (LL)
- 8) TROT, TWO TRACK LEFT
- 9) EXTENDED TROT
- 10) STOP, 360° TURNS (EACH DIRECTION)
- 11) LOPE (LL)
- 12) WALK, STOP, BACK UP

WALK (SCHRITT)	
EXTENDED WALK	
JOG/TROT (TRAB)	
EXTENDED TROT	
LOPE (GALOPP)	
EXTENDED LOPE	
BACK UP (RÜCKWÄRTS)	
LEAD CHANGE (GALOPPWECHSEL)	
TURN (DREHUNG)	
ERSTE	
WESTENREITER	
UNION	
WESTENREITER	

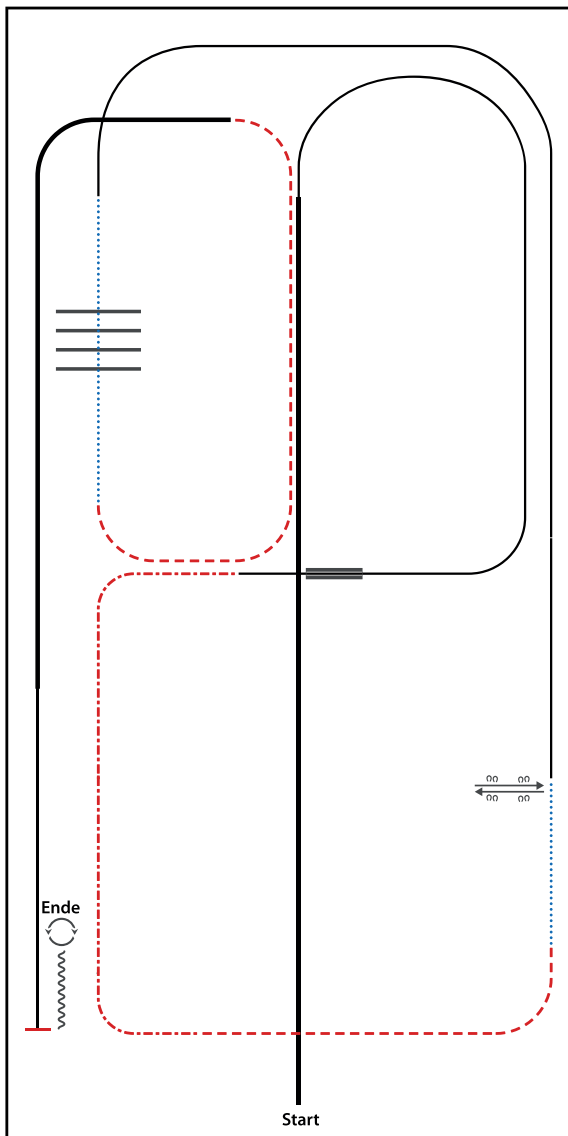

- 1) EXTENDED LOPE (RL)
- 2) LOPE (RL)
- 3) LEADCHANGE (SIMPLE OR FLYING), LOPE (LL)
- 4) EXTENDED TROT
- 5) TROT
- 6) WALK
- 7) SIDEPASS LEFT, SIDEPASS RIGHT
- 8) LOPE (LL)
- 9) WALK OVER
- 10) TROT
- 11) EXTENDED LOPE (LL), LOPE (LL)
- 12) STOP, BACK UP
- 13) 360° TURNS (EACH DIRECTION)

WALK (SCHRITT)	
EXTENDED WALK	
JOG/TROT (TRAB)	
EXTENDED TROT	
LOPE (GALOPP)	
EXTENDED LOPE	
BACK UP (RÜCKWÄRTS)	
LEAD CHANGE (GALOPPWECHSEL)	
TURN (DREHUNG)	
	ERSTE
	WESTENREITER
	UNION
	WELDFERREITERBUND

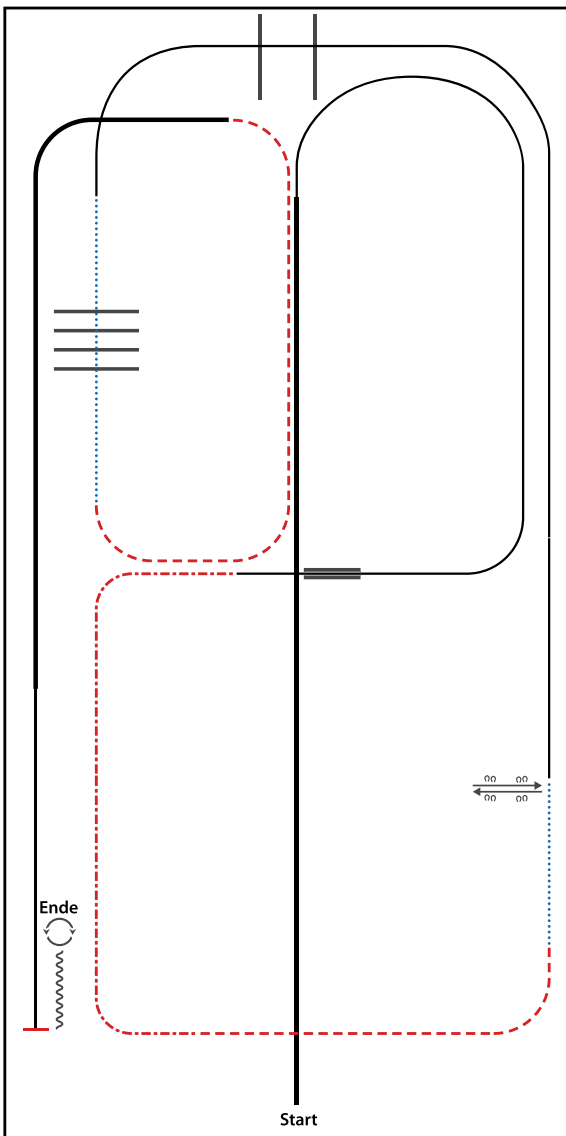

- 1) EXTENDED LOPE (RL)
- 2) LOPE (RL)
- 3) LEADCHANGE (SIMPLE OR FLYING), LOPE (LL)
- 4) EXTENDED TROT
- 5) TROT
- 6) WALK
- 7) SIDEPASS LEFT, SIDEPASS RIGHT
- 8) LOPE (LL), LOPE OVER
- 9) WALK OVER
- 10) TROT
- 11) EXTENDED LOPE (LL), LOPE (LL)
- 12) STOP, BACK UP
- 13) 360° TURNS (EACH DIRECTION)

WALK (SCHRITT)	
EXTENDED WALK	
JOG/TROT (TRAB)	
EXTENDED TROT	
LOPE (GALOPP)	
EXTENDED LOPE	
BACK UP (RÜCKWÄRTS)	
LEAD CHANGE (GALOPPWECHSEL)	
TURN (DREHUNG)	
	ERSTE
	WESTENREITER
	UNION
	WELDFERREITERBUND
	WESTERUNION

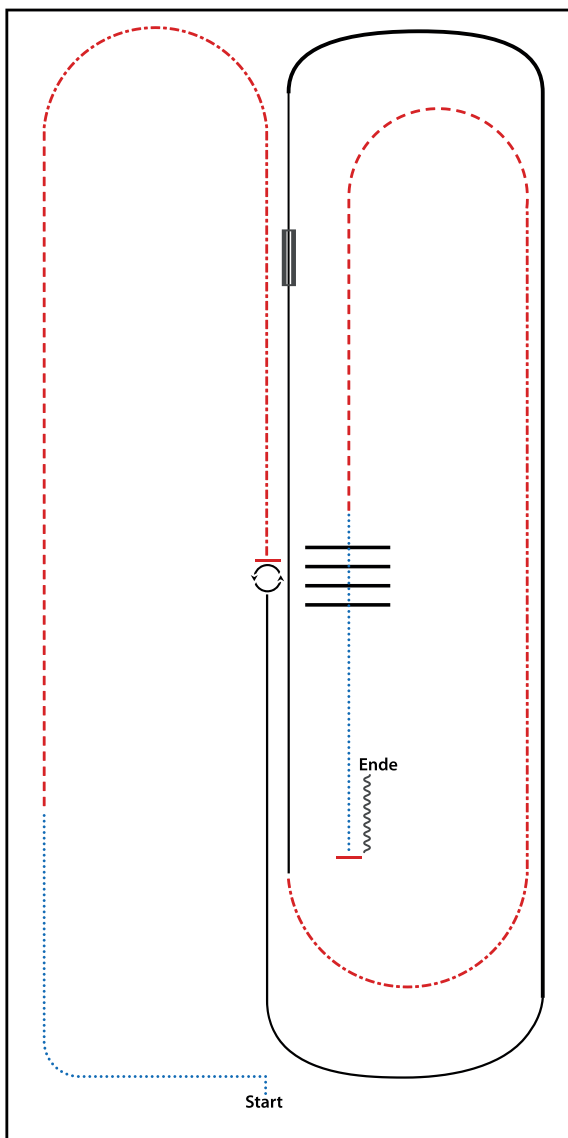

- 1) WALK
- 2) TROT
- 3) EXTENDED TROT
- 4) STOP, 360° TURNS (EACH DIRECTION)
- 5) LOPE (LL)
- 6) EXTENDED LOPE (LL)
- 7) LOPE (LL), LEADCHANGE (SIMPLE OR FLYING)
- 8) LOPE (RL)
- 9) EXTENDED TROT
- 10) TROT
- 11) WALK OVER
- 12) STOP, BACK UP

WALK (SCHRITT)	
EXTENDED WALK	
JOG/TROT (TRAB)	
EXTENDED TROT	
LOPE (GALOPP)	
EXTENDED LOPE	
BACK UP (RÜCKWÄRTS)	
LEAD CHANGE (GALOPPWECHSEL)	
TURN (DREHUNG)	
ERSTE	
WESTENREITER	
UNION	
WESTENREITER	

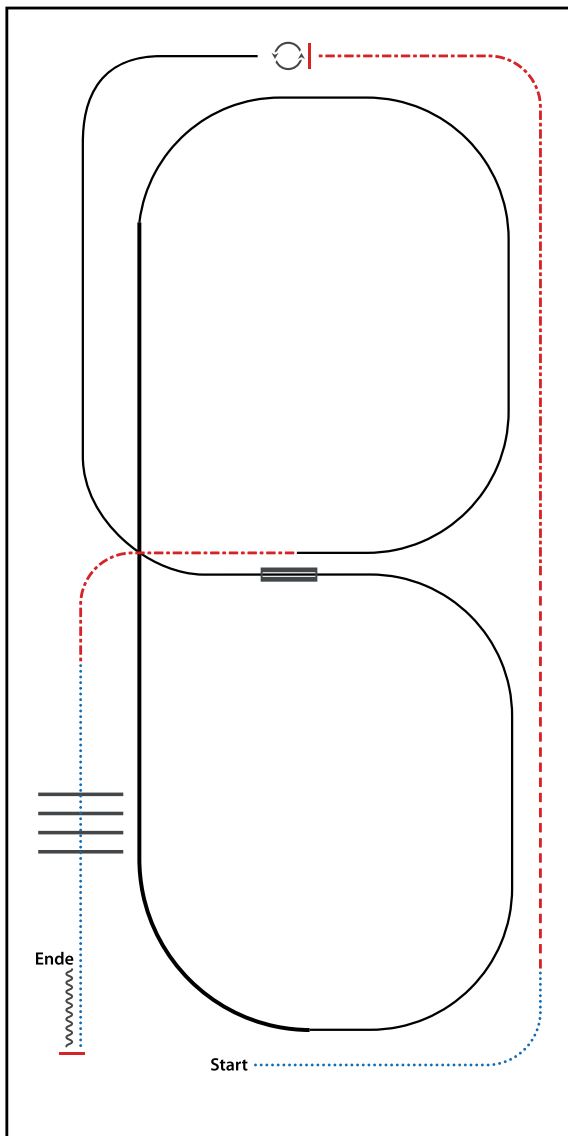

- 1) WALK
- 2) TROT
- 3) EXTENDED TROT, STOP
- 4) 360° TURN LEFT
- 5) LOPE (LL)
- 6) LEADCHANGE (SIMPLE OR FLYING)
- 7) LOPE (RL)
- 8) EXTENDED LOPE (RL)
- 9) LOPE (RL)
- 10) EXTENDED TROT
- 11) WALK OVER
- 12) STOP, BACK UP

WALK (SCHRITT)	
EXTENDED WALK	
JOG/TROT (TRAB)	
EXTENDED TROT	
LOPE (GALOPP)	
EXTENDED LOPE	
BACK UP (RÜCKWÄRTS)	
LEAD CHANGE (GALOPPWECHSEL)	
TURN (DREHUNG)	
	ERSTE
	WESTENREITER
	UNION
	WELDFERREITERBUND

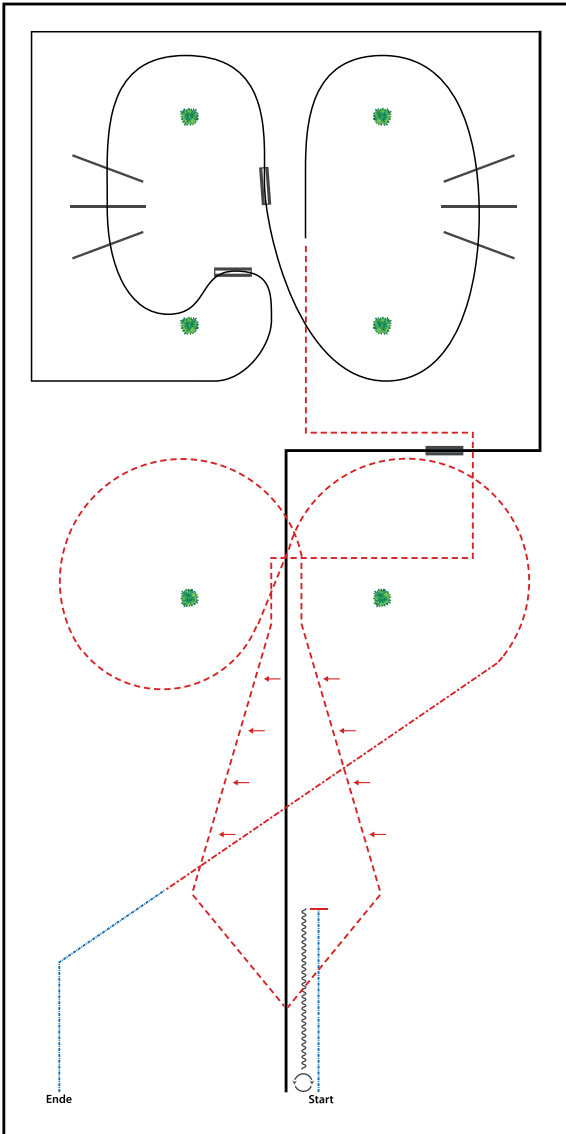

- 1) EXTENDED WALK
- 2) STOP, BACK UP
- 3) TWO TURNS (LEFT OR RIGHT)
- 4) EXTENDED LOPE (RL) CORNER
- 5) LEADCHANGE (SIMPLE OR FLYING)
- 6) EXTENDED LOPE (LL) CORNER
- 7) COLLECTED LOPE (LL) CORNERS
- 8) LEADCHANGE (SIMPLE OR FLYING), LOPE OVER (RL)
- 9) LEADCHANGE (SIMPLE OR FLYING), LOPE OVER (LL)
- 10) TROT CORNERS
- 11) TWO TRACK RIGHT, CORNERS, TWO TRACK LEFT
- 12) EXTENDED TROT
- 13) EXTENDED WALK, WALK OUT

WALK (SCHRITT)	
EXTENDED WALK	
JOG/TROT (TRAB)	
EXTENDED TROT	
LOPE (GALOPP)	
EXTENDED LOPE	
BACK UP (RÜCKWÄRTS)	
LEAD CHANGE (GALOPPWECHSEL)	
TURN (DREHUNG)	
	ERSTE
	WESTENREITER
	UNION
	WIRTSCHAFTSUNIVERSITÄT SIEGEN

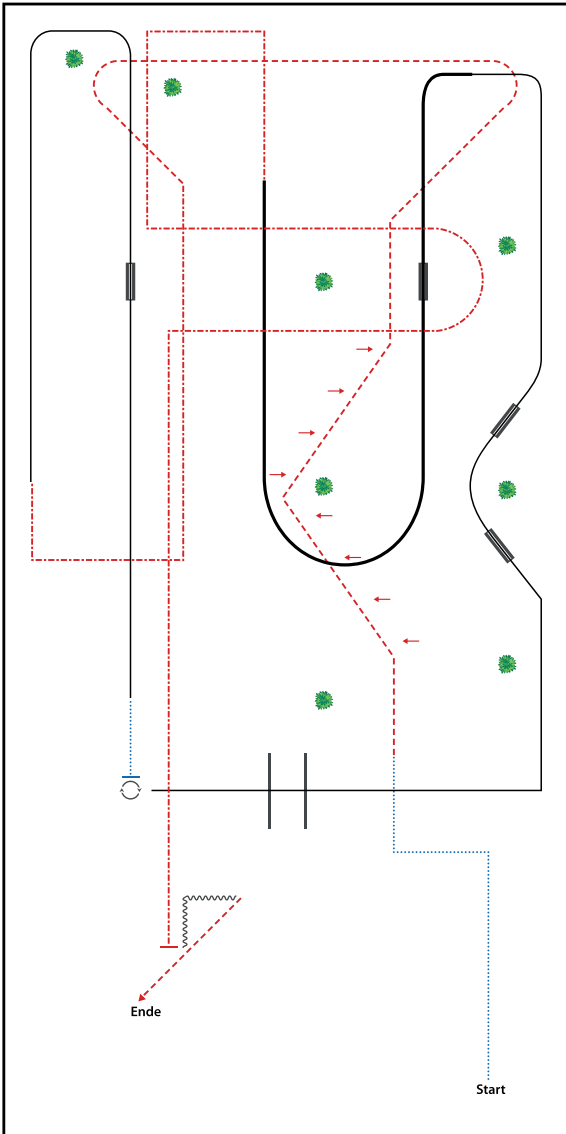

- 1) WALK CORNER
- 2) TROT, TWO TRACK LEFT AND RIGHT
- 3) TROT CORNERS
- 4) EXTENDED TROT CORNERS
- 5) LOPE (RL)
- 6) LEADCHANGE (SIMPLE OR FLYING), LOPE (LL)
- 7) WALK, STOP
- 8) 3/4 TURN RIGHT
- 9) LOPE (LL), LOPE OVER
- 10) LOPE SERPENTINE, TWO LEADCHANGES (SIMPLE OR FLYING)
- 11) EXTENDED LOPE (LL)
- 12) LEADCHANGE (SIMPLE OR FLYING), EXTENDED LOPE (RL)
- 13) EXTENDED TROT CORNERS, ARC AND CORNER
- 14) STOP, BACK UP, TROT OUT

WALK (SCHRITT)	
EXTENDED WALK	
JOG/TROT (TRAB)	
EXTENDED TROT	
LOPE (GALOPP)	
EXTENDED LOPE	
BACK UP (RÜCKWÄRTS)	
LEAD CHANGE (GALOPPWECHSEL)	
TURN (DREHUNG)	
ERSTE	
WESTENREITER	
UNION	
WELDPFERDEBUND WESTERWALD	

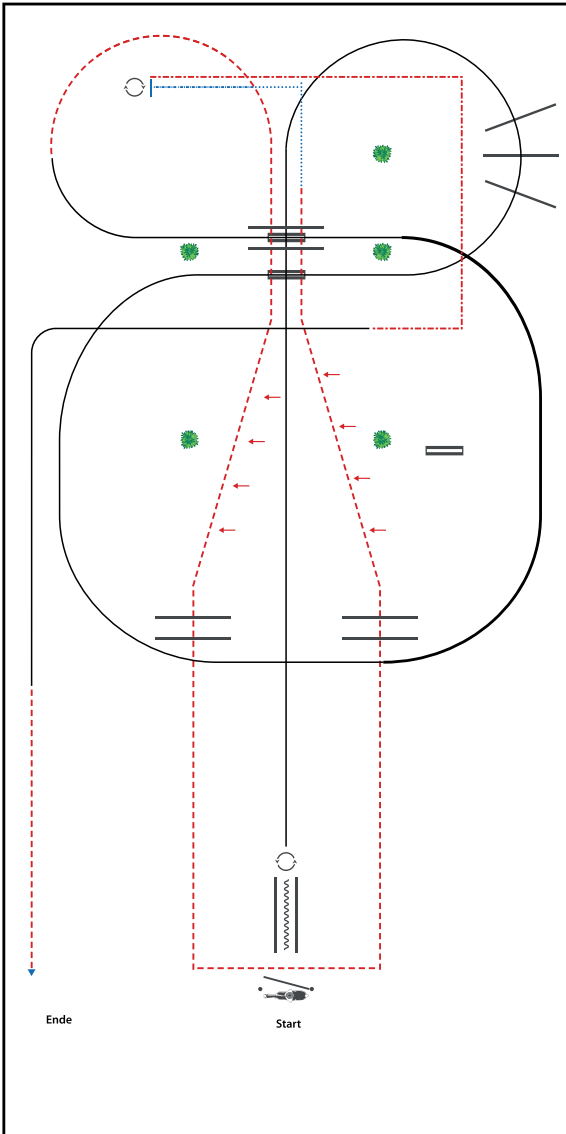

- 1) GATE
- 2) BACK UP
- 3) 1½ TURN LEFT
- 4) LOPE (RL), LOPE OVER
- 5) LEADCHANGE (SIMPLE OR FLYING), LOPE (LL)
- 6) EXTENDED LOPE (LL), COLLECTED LOPE (LL)
- 7) LEADCHANGE (SIMPLE OR FLYING), LOPE (RL)
- 8) TROT, TROT OVER, TWO TRACK RIGHT AND LEFT
- 9) WALK, EXTENDED WALK
- 10) 1½ TURN RIGHT
- 11) EXTENDED TROT CORNERS
- 12) LOPE (LL) CORNER, TROT OUT

WALK (SCHRITT)
EXTENDED WALK
JOG/TROT (TRAB)
EXTENDED TROT
LOPE (GALOPP)
EXTENDED LOPE
BACK UP (RÜCKWÄRTS)
LEAD CHANGE (GALOPPWECHSEL)
TURN (DREHUNG)
ERSTE
WESTENREITER
UNION
WESTENREITER

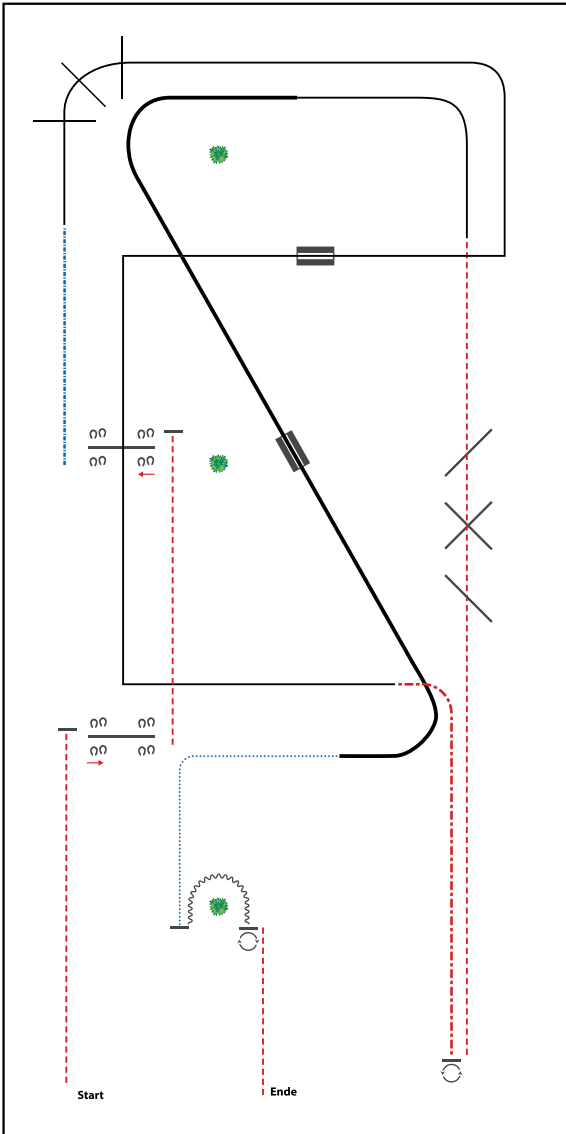

- 1) TROT, STOP, SIDEPASS RIGHT
- 2) TROT, STOP, SIDEPASS LEFT
- 3) EXTENDED WALK
- 4) LOPE (RL), LOPE OVER
- 5) LEADCHANGE (SIMPLE OR FLYING)
- 6) LOPE CORNERS (LL), LOPE OVER
- 7) EXTENDED TROT, STOP
- 8) 1½ TURN LEFT
- 9) TROT, TROT OVER
- 10) LOPE (LL), EXTENDED LOPE (LL)
- 11) LEADCHANGE (SIMPLE OR FLYING), EXTENDED LOPE (RL)
- 12) WALK, STOP
- 13) BACK UP
- 14) 1½ TURN RIGHT, TROT OUT

WALK (SCHRITT)
EXTENDED WALK
JOG/TROT (TRAB)
EXTENDED TROT
LOPE (GALOPP)
EXTENDED LOPE
BACK UP (RÜCKWÄRTS)	~~~~~
LEAD CHANGE (GALOPPWECHSEL)	=====
TURN (DREHUNG)	⤿
ERSTE	=====
WESTENREITER	=====
UNION	=====
WESTENREITER	=====

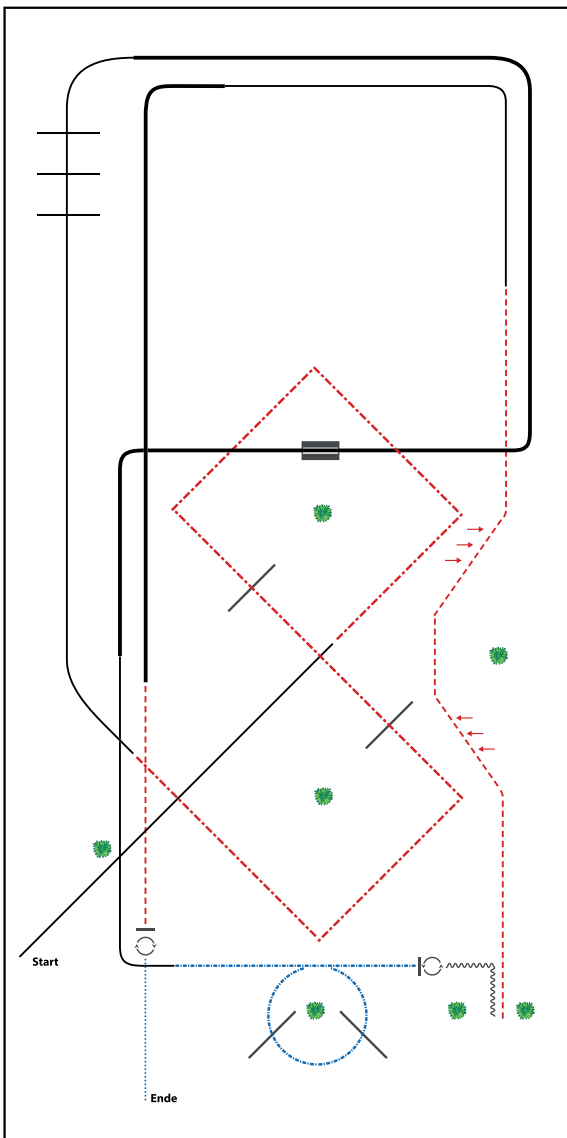

- 1) LOPE (RL OR LL)
- 2) EXTENDED TROT CORNERS, EXTENDED TROT OVER
- 3) LOPE (RL), LOPE OVER
- 4) EXTENDED LOPE (RL)
- 5) LEADCHANGE (SIMPLE OR FLYING)
- 6) EXTENDED LOPE (LL), LOPE (LL)
- 7) EXTENDED WALK OVER
- 8) STOP, 1½ TURN LEFT
- 9) BACK UP
- 10) TROT, TWO TACK LEFT AND RIGHT
- 11) LOPE (LL), EXTENDED LOPE (LL)
- 12) TROT, STOP
- 13) 2 TURNS RIGHT
- 14) WALK OUT

WALK (SCHRITT)
EXTENDED WALK
JOG/TROT (TRAB)
EXTENDED TROT
LOPE (GALOPP)
EXTENDED LOPE
BACK UP (RÜCKWÄRTS)
LEAD CHANGE (GALOPPWECHSEL)
TURN (DREHUNG)
ERSTE WESTENREITER
UNION
WESTENREITER

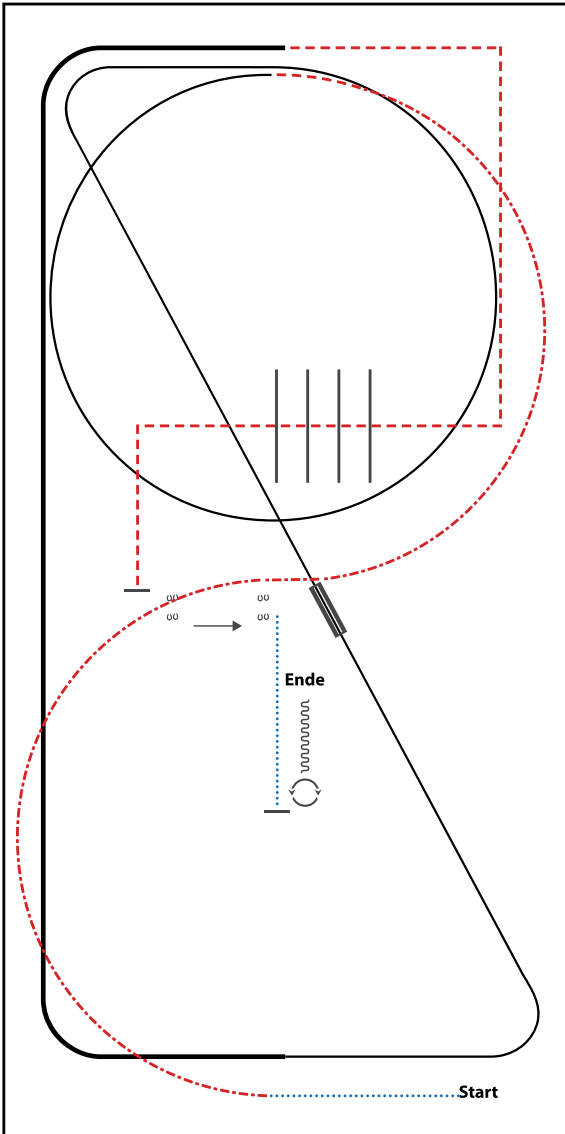

- 1) WALK
- 2) EXTENDED TROT, TROT
- 3) LOPE (LL) CIRCLE, LOPE (LL)
- 4) LEADCHANGE (SIMPLE OR FLYING)
- 5) LOPE (RL)
- 6) EXTENDED LOPE (RL)
- 7) TROT CORNERS
- 8) TROT OVER, TROT
- 9) STOP, SIDEPASS LEFT
- 10) WALK, STOP
- 11) 360° TURN (LEFT OR RIGHT), BACK UP

WALK (SCHRITT)
EXTENDED WALK
JOG/TROT (TRAB)
EXTENDED TROT
LOPE (GALOPP)
EXTENDED LOPE
BACK UP (RÜCKWÄRTS)
LEAD CHANGE (GALOPPWECHSEL)
TURN (DREHUNG)
	ERSTE
	WESTENREITER
	UNION
	WELDPFERDEBUND WESTERWOLFE

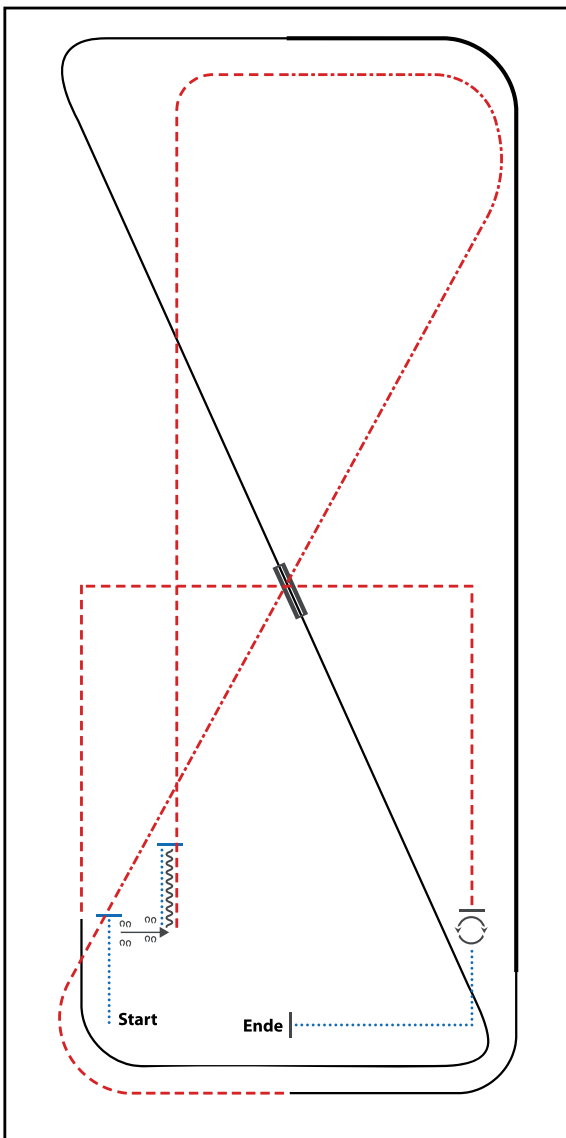

- 1) WALK, STOP
- 2) SIDEPASS RIGHT
- 3) WALK, STOP, BACK UP
- 4) TROT
- 5) EXTENDED TROT, TROT
- 6) LOPE (LL)
- 7) EXTENDED LOPE (LL), LOPE (LL)
- 8) LEADCHANGE (SIMPLE OR FLYING)
- 9) LOPE (RL)
- 10) TROT CORNERS
- 11) STOP, 360° TURN (LEFT OR RIGHT)
- 12) WALK, STOP

WALK (SCHRITT)
EXTENDED WALK
JOG/TROT (TRAB)
EXTENDED TROT
LOPE (GALOPP)
EXTENDED LOPE
BACK UP (RÜCKWÄRTS)
LEAD CHANGE (GALOPPWECHSEL)
TURN (DREHUNG)
ERSTE
WESTENREITER
UNION
WESTENREITER

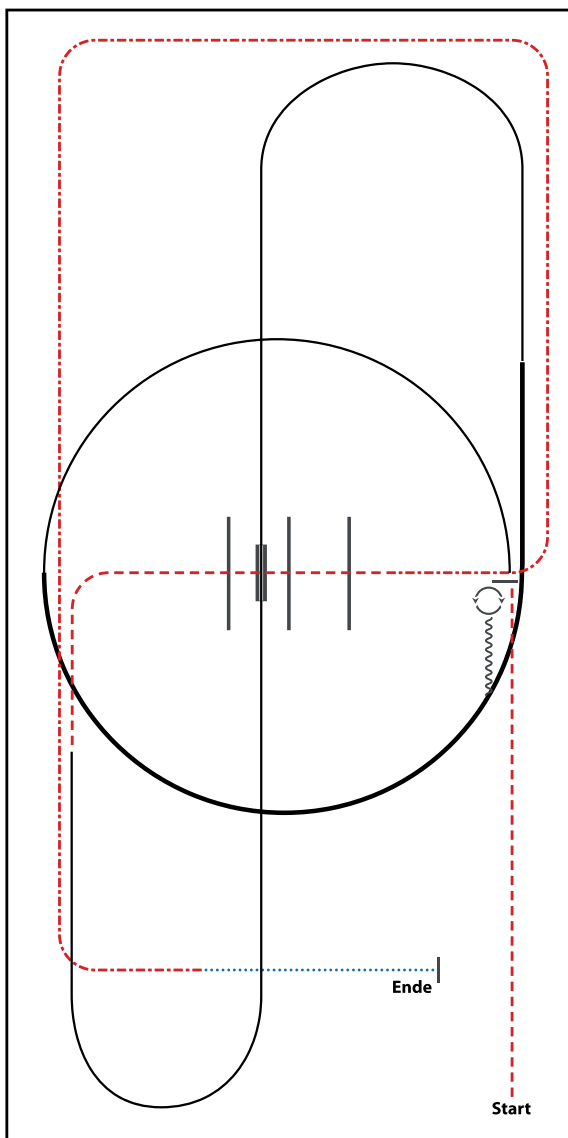

- 1) TROT
- 2) STOP, 180° TURNS EACH DIRECTION
- 3) BACK UP
- 4) LOPE (LL)
- 5) EXTENDED LOPE (LL), LOPE (LL)
- 6) LEADCHANGE (SIMPLE OR FLYING)
- 7) LOPE (RL)
- 8) TROT, TROT OVER
- 9) EXTENDED TROT
- 10) WALK, STOP

WALK (SCHRITT)	
EXTENDED WALK	
JOG/TROT (TRAB)	
EXTENDED TROT	
LOPE (GALOPP)	
EXTENDED LOPE	
BACK UP (RÜCKWÄRTS)	
LEAD CHANGE (GALOPPWECHSEL)	
TURN (DREHUNG)	
	ERSTE
	WESTENREITER
	UNION
	WELDMANN/SCHNEIDER

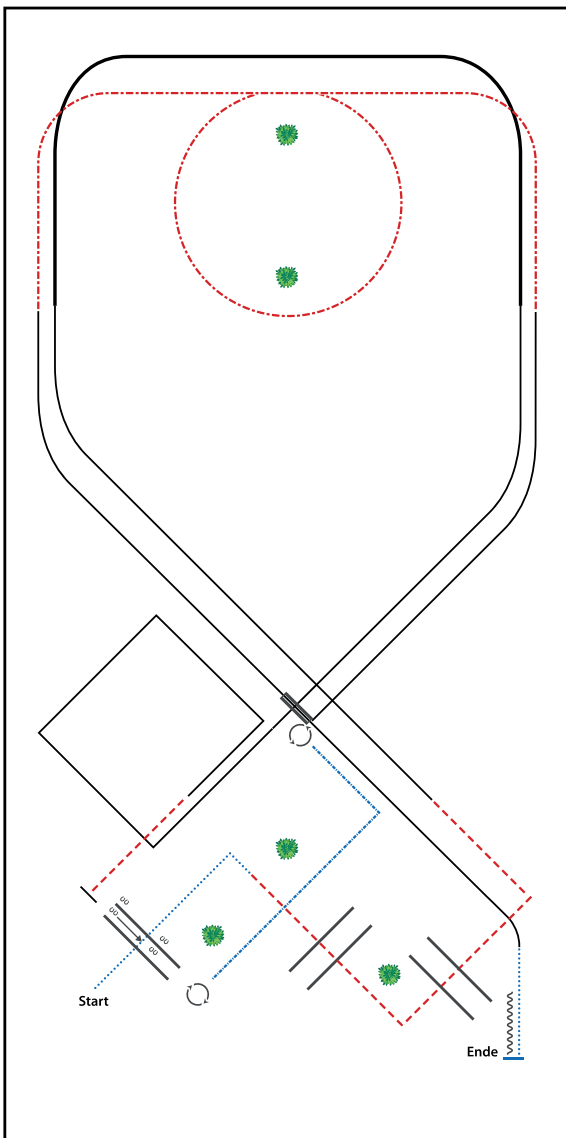

- 1) WALK OVER, WALK CORNER
- 2) TROT OVER AND CORNER
- 3) LOPE (RL)
- 4) EXTENDED LOPE (RL)
- 5) COLLECTED LOPE (RL), LOPE CORNERS
- 6) TROT, STOP
- 7) SIDEPASS LEFT
- 8) 1½ TURN LEFT
- 9) EXTENDED WALK CORNER
- 10) STOP, 1¼ TURN RIGHT
- 11) LOPE (LL)
- 12) EXTENDED TROT
- 13) LOPE (LL), LEADCHANGE (SIMPLE OR FLYING), LOPE (RL)
- 14) WALK, STOP, BACK UP

WALK (SCHRITT)
EXTENDED WALK	-----
JOG/TROT (TRAB)	- - - - -
EXTENDED TROT
LOPE (GALOPP)	—————
EXTENDED LOPE	—————
BACK UP (RÜCKWÄRTS)	~~~~~
LEAD CHANGE (GALOPPWECHSEL)	—————
TURN (DREHUNG)	⊙
	ERSTE WESTENREITER UNION WELSH/GERMAN/AMERICAN

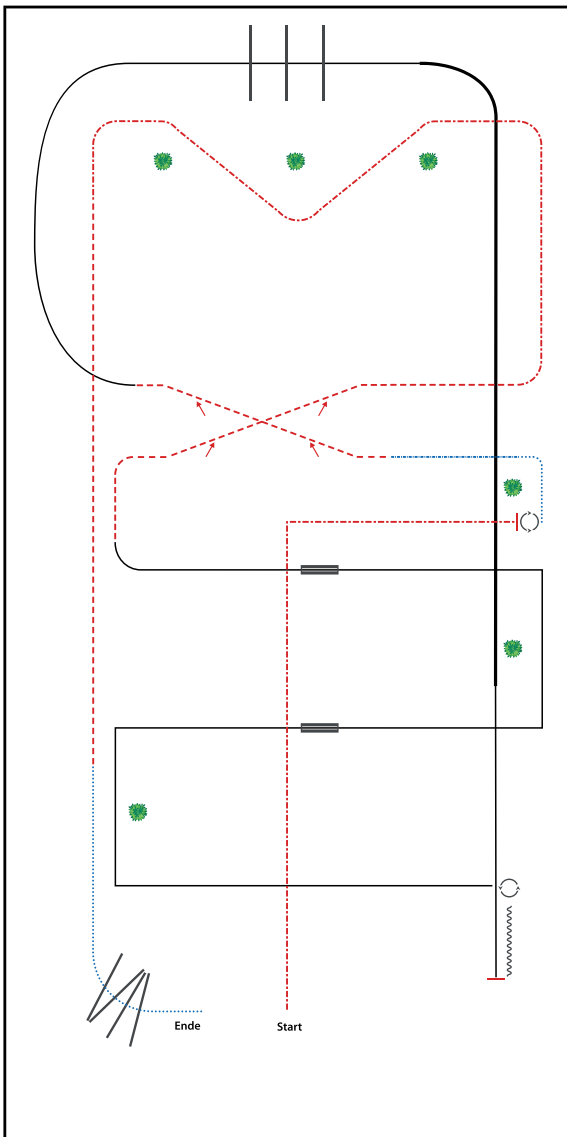

- 1) EXTENDED TROT CORNER
- 2) STOP, 2¼ TURN LEFT
- 3) WALK, EXTENDED WALK
- 4) TROT, TWO TRACK RIGHT
- 5) LOPE (RL), LOPE OVER
- 6) EXTENDED LOPE (RL), COLLECTED LOPE (RL)
- 7) STOP, BACK UP
- 8) 2¼ TURN RIGHT
- 9) LOPE (RL) CORNERS
- 10) LEADCHANGE (SIMPLE OR FLYING), LOPE (RL) CORNERS
- 11) LEADCHANGE (SIMPLE OR FLYING), LOPE (RL)
- 12) TROT, TWO TRACK LEFT
- 13) EXTENDED TROT, TROT
- 14) WALK, WALK OVER, WALK OUT

WALK (SCHRITT)
EXTENDED WALK
JOG/TROT (TRAB)
EXTENDED TROT
LOPE (GALOPP)
EXTENDED LOPE
BACK UP (RÜCKWÄRTS)	~~~~~
LEAD CHANGE (GALOPPWECHSEL)
TURN (DREHUNG)	⤵
ERSTE
WESTENREITER
UNION
WESTENREITER

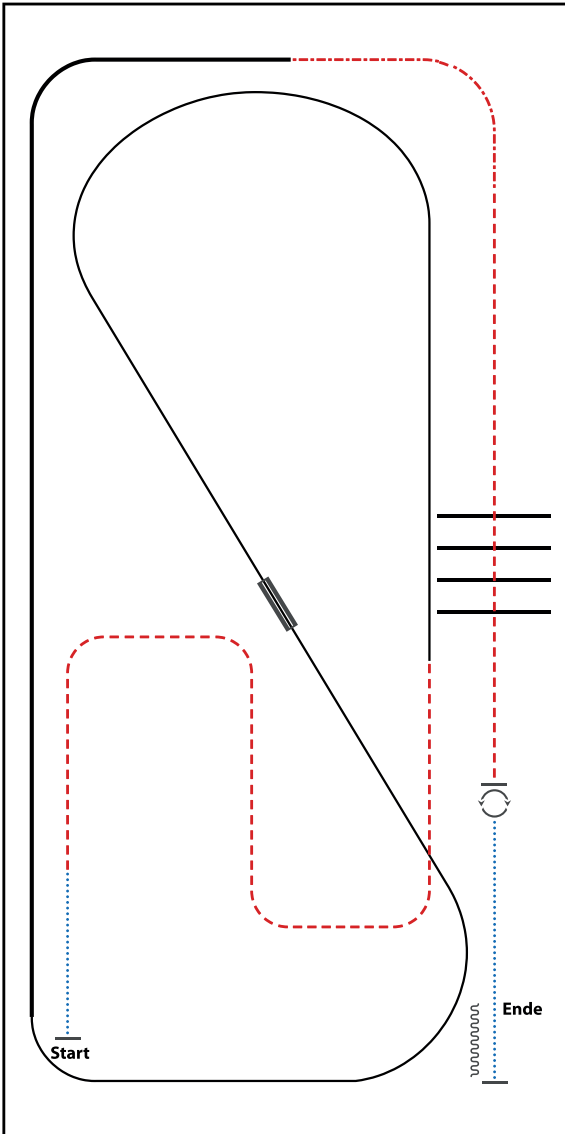

- 1) WALK
- 2) TROT
- 3) LOPE (LL)
- 4) LEADCHANGE (SIMPLE OR FLYING)
- 5) LOPE (RL)
- 6) EXTENDED LOPE (RL)
- 7) EXTENDED TROT
- 8) TROT
- 9) TROT OVER
- 10) STOP, 360° TURNS (EACH DIRECTION)
- 11) WALK, STOP, BACK UP

WALK (SCHRITT)	
EXTENDED WALK	
JOG/TROT (TRAB)	
EXTENDED TROT	
LOPE (GALOPP)	
EXTENDED LOPE	
BACK UP (RÜCKWÄRTS)	
LEAD CHANGE (GALOPPWECHSEL)	
TURN (DREHUNG)	
	ERSTE
	WESTENREITER
	UNION
	WESTENREITER

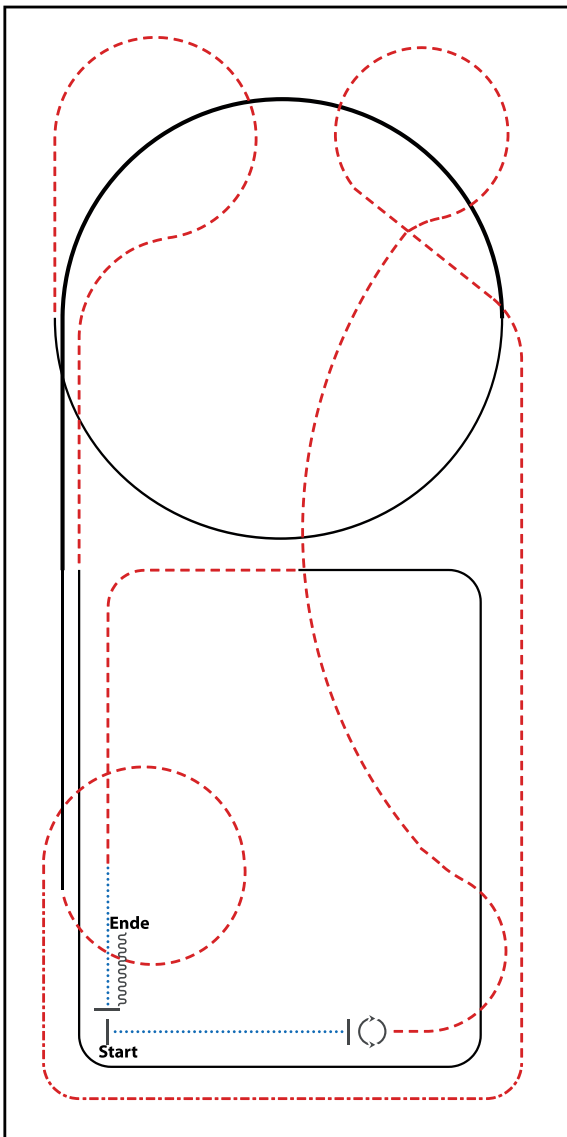

- 1) WALK
- 2) STOP, 360° TURNS (EACH DIRECTION)
- 3) TROT
- 4) EXTENDED TROT, TROT
- 5) LOPE (RL), EXTENDED LOPE (RL), LOPE (RL)
- 6) TROT
- 7) LOPE (LL)
- 8) TROT, WALK
- 9) STOP, BACK UP

WALK (SCHRITT)	
EXTENDED WALK	
JOG/TROT (TRAB)	
EXTENDED TROT	
LOPE (GALOPP)	
EXTENDED LOPE	
BACK UP (RÜCKWÄRTS)	
LEAD CHANGE (GALOPPWECHSEL)	
TURN (DREHUNG)	
	ERSTE
	WESTENREITER
	UNION
	WELDPFERDEBUND WESTENREITER

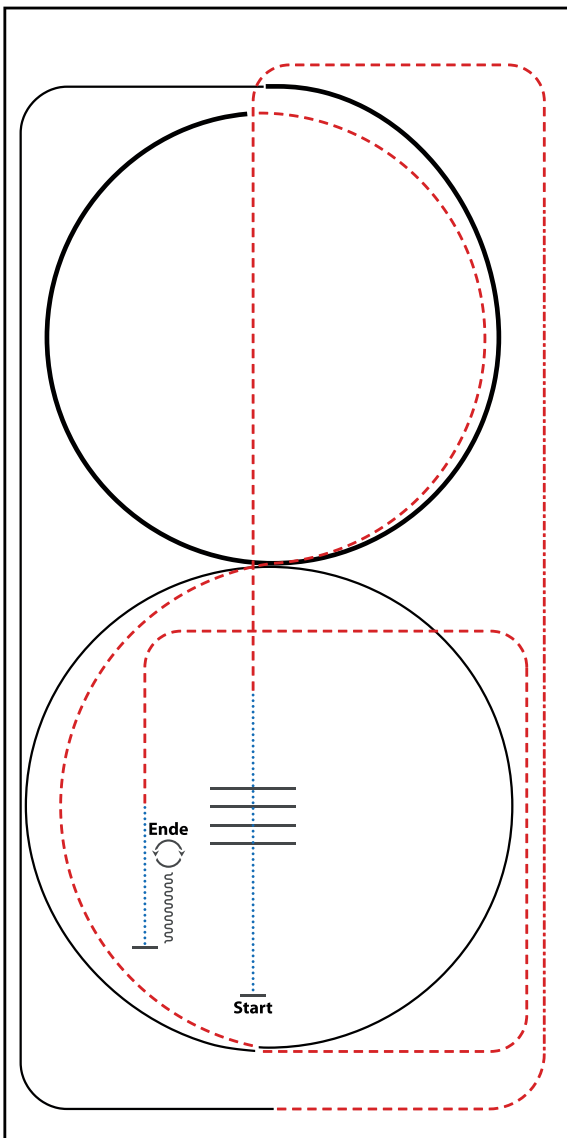

- 1) WALK, WALK OVER
- 2) TROT
- 3) EXTENDED TROT, TROT
- 4) LOPE (RL)
- 5) EXTENDED LOPE (RL)
- 6) TROT (2x ½ CIRCLE)
- 7) LOPE (LL)
- 8) TROT
- 9) WALK
- 10) STOP, BACK UP
- 11) 180° TURN RIGHT
- 12) 180° TURN LEFT

WALK (SCHRITT)	
EXTENDED WALK	
JOG/TROT (TRAB)	
EXTENDED TROT	
LOPE (GALOPP)	
EXTENDED LOPE	
BACK UP (RÜCKWÄRTS)	
LEAD CHANGE (GALOPPWECHSEL)	
TURN (DREHUNG)	
	ERSTE
	WESTENREITER
	UNION
	WELDPFERDEBUND WESTENREITER

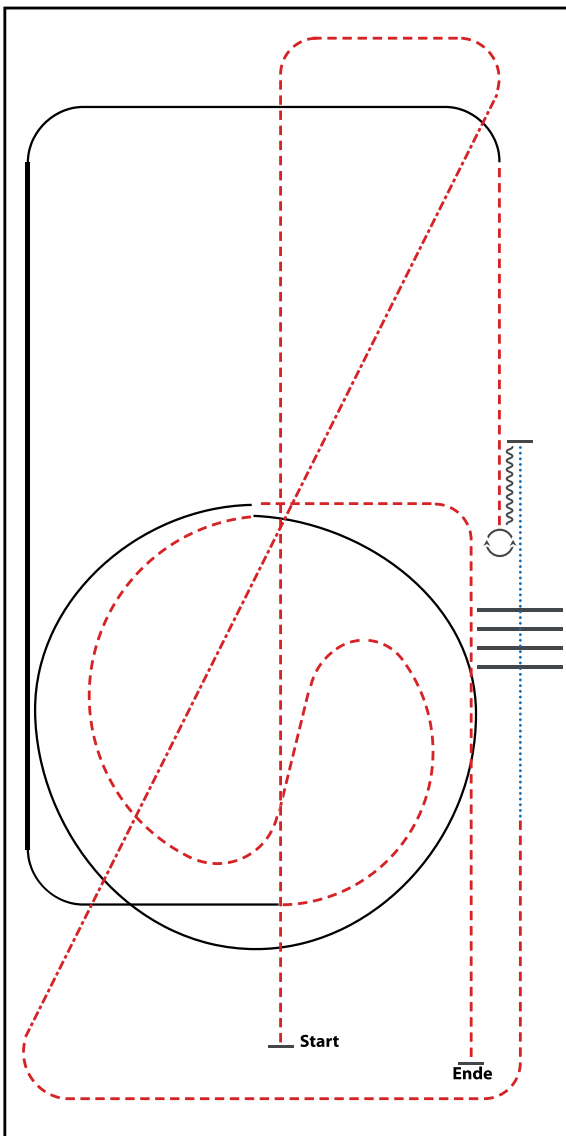

- 1) TROT
- 2) EXTENDED TROT, TROT
- 3) WALK OVER
- 4) WALK
- 5) STOP, BACK UP
- 6) 180° TURN RIGHT
- 7) 180° TURN LEFT
- 8) TROT
- 9) LOPE (LL)
- 10) EXTENDED LOPE (LL), LOPE (LL)
- 11) TROT
- 12) LOPE (RL)
- 13) TROT, STOP

WALK (SCHRITT)	
EXTENDED WALK	
JOG/TROT (TRAB)	
EXTENDED TROT	
LOPE (GALOPP)	
EXTENDED LOPE	
BACK UP (RÜCKWÄRTS)	
LEAD CHANGE (GALOPPWECHSEL)	
TURN (DREHUNG)	
	ERSTE
	WESTENREITER
	UNION
	WELDPFERDEBUND

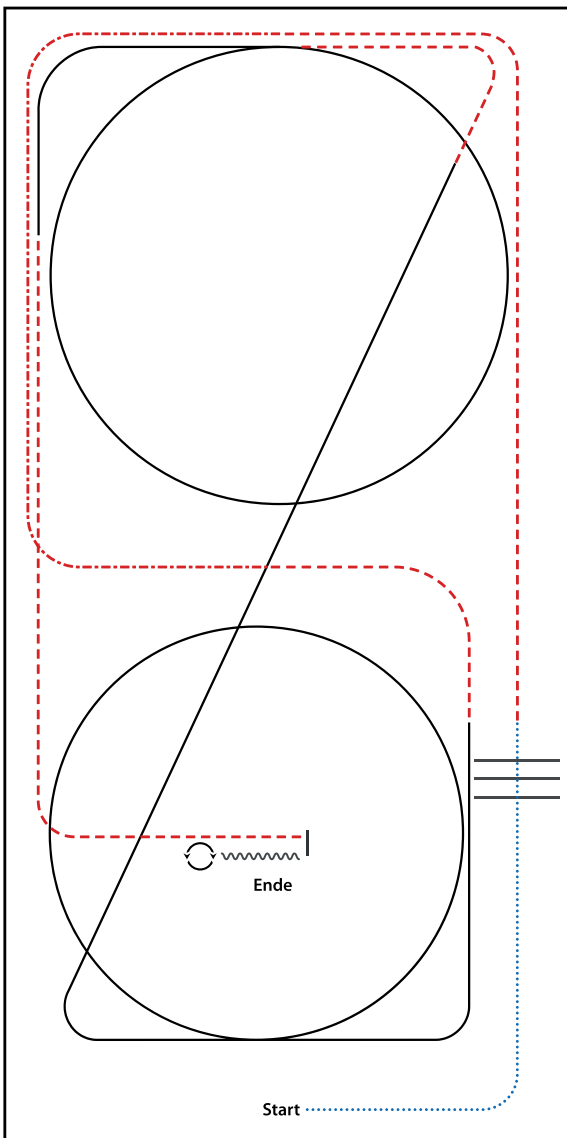

- 1) WALK,
- 2) WALK OVER, WALK
- 3) TROT
- 4) EXTENDED TROT CORNERS, TROT
- 5) LOPE (RL) CIRCLE, LOPE
- 6) TROT
- 7) LOPE (LL) CIRCLE
- 8) TROT
- 9) STOP, BACK UP
- 10) 360° TURN (LEFT OR RIGHT)

WALK (SCHRITT)	
EXTENDED WALK	
JOG/TROT (TRAB)	
EXTENDED TROT	
LOPE (GALOPP)	
EXTENDED LOPE	
BACK UP (RÜCKWÄRTS)	
LEAD CHANGE (GALOPPWECHSEL)	
TURN (DREHUNG)	
	ERSTE
	WESTENREITER
	UNION
	WELDFÖRDERNDE VEREINIGUNG

